

Range Number	Number of particles per ml More than	Up to and including
24	80,000	160,000
23	40,000	80,000
22	20,000	40,000
21	10,000	20,000
20	5,000	10,000
19	2,500	5,000
18	1,300	2,500
17	640	1,300
16	320	640
15	160	320
14	80	160
13	40	80
12	20	40
11	10	20

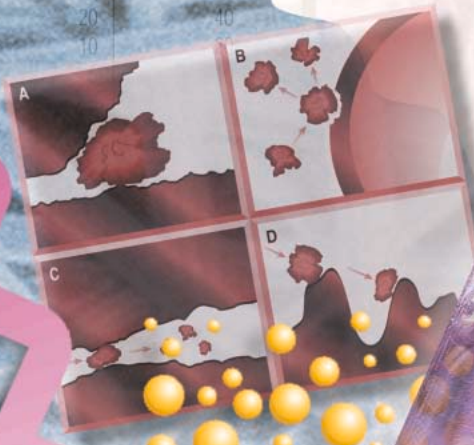

***The Handbook of Hydraulic Filtration is intended to familiarize the user with all aspects of hydraulic and lubrication filtration from the basics to advanced technology.***

***It is dedicated as a reference source with the intent of clearly and completely presenting the subject matter to the user, regardless of the individual level of expertise.***

***The selection and proper use of filtration devices is an important tool in the battle to increase production while reducing manufacturing costs. This Handbook will help the user make informed decisions about hydraulic filtration.***

# Table of Contents

<b>SECTION</b>	<b>PAGE</b>
<b>Contamination Basics</b>	<b>2</b>
<b>Contamination Types and Sources</b>	<b>4</b>
<b>Fluid Cleanliness Standards</b>	<b>12</b>
<b>Filter Media Types and Ratings</b>	<b>16</b>
<b>Filter Media Selection</b>	<b>20</b>
<b>Filter Element Life</b>	<b>22</b>
<b>Filter Housing Selection</b>	<b>24</b>
<b>Types and Locations of Filters</b>	<b>28</b>
<b>Fluid Analysis</b>	<b>32</b>
<b>Appendix</b>	<b>34</b>



# Contamination Basics

## Filtration Fact

*Properly sized, installed, and maintained hydraulic filtration plays a key role in machine preventative maintenance planning.*

## Filtration Fact

*The function of a hydraulic filter is to clean oil, but the ultimate purpose is to reduce operating costs.*

## Filtration Fact

*The disposal cost of a drum of waste oil can be 4X - 5X the cost of a drum of new oil.*

### Contamination Causes Most Hydraulic Failures

The experience of designers and users of hydraulic and lube oil systems has verified the following fact: over 75% of all system failures are a direct result of contamination!

The cost due to contamination is staggering, resulting from:

- ▼ Loss of production (downtime)
- ▼ Component replacement costs
- ▼ Frequent fluid replacement
- ▼ Costly disposal
- ▼ Increased overall maintenance costs
- ▼ Increased scrap rate

### Functions of Hydraulic Fluid

Contamination interferes with the four functions of hydraulic fluids:

1. To act as an energy transmission medium.
2. To lubricate internal moving parts of components.
3. To act as a heat transfer medium.
4. To seal clearances between moving parts.

If any one of these functions is impaired, the hydraulic system will not perform as designed. The resulting downtime can easily cost a large manufacturing plant thousands of dollars per hour. Hydraulic fluid maintenance helps prevent or reduce unplanned downtime. This is accomplished through a continuous improvement program that minimizes and removes contaminants.

### Contaminant Damage

- ▼ Orifice blockage
- ▼ Component wear
- ▼ Formation of rust or other oxidation
- ▼ Chemical compound formation
- ▼ Depletion of additives
- ▼ Biological growth

Hydraulic fluid is expected to create a lubricating film to keep precision parts separated. Ideally, the film is thick enough to completely fill the clearance between moving parts. This condition results in low wear rates. When the wear rate is kept low enough, a component is likely to reach its intended life expectancy, which may be millions of pressurization cycles.

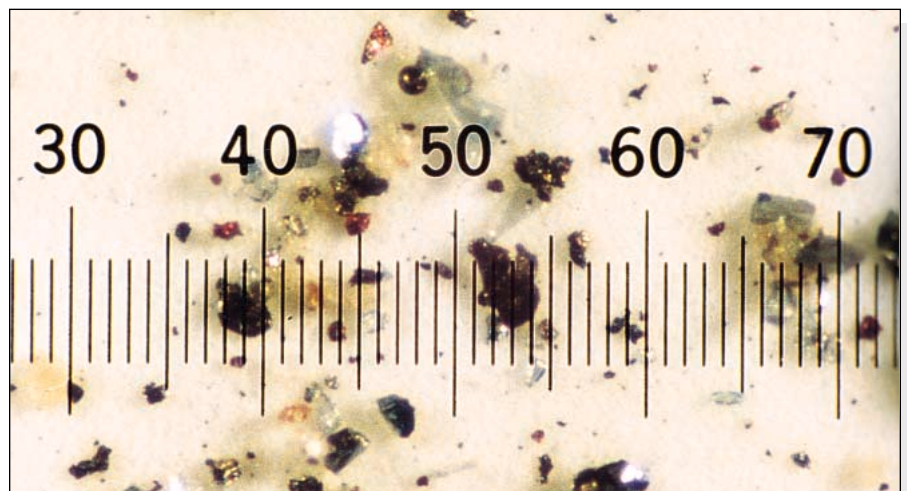

Actual photomicrograph of particulate contamination (Magnified 100x Scale: 1 division = 20 microns)



# Contamination Basics

The actual thickness of a lubricating film depends on fluid viscosity, applied load, and the relative speed of the two surfaces. In many components, mechanical loads are to such an extreme that they squeeze the lubricant into a very thin film, less than 1 micrometer thick. If loads become high enough, the film will be punctured by the surface roughness of the two moving parts. The result contributes to harmful friction.

Typical Hydraulic Component Clearances	
Component	Microns
Anti-friction bearings	0.5
Vane pump (vane tip to outer ring)	0.5-1
Gear pump (gear to side plate)	0.5-5
Servo valves (spool to sleeve)	1-4
Hydrostatic bearings	1-25
Piston pump (piston to bore)	5-40
Servo valves flapper wall	18-63
Actuators	50-250
Servo valves orifice	130-450

Relative Sizes of Particles		
Substance	Microns	Inches
Grain of table salt	100	.0039
Human hair	70	.0027
Lower limit of visibility	40	.0016
Milled flour	25	.0010
Red blood cells	8	.0003
Bacteria	2	.0001

## Micrometer Scale

Particle sizes are generally measured on the micrometer scale. One micrometer (or “micron”) is one-millionth of one meter, or 39 millionths of an inch. The limit of human visibility is approximately 40 micrometers. Keep in mind that most damage-causing particles in hydraulic or lubrication systems are smaller than 40 micrometers. Therefore, they are microscopic and cannot be seen by the unaided eye.



# Contamination Types and Sources

## Filtration Fact

*New fluid is not necessarily clean fluid. Typically, new fluid right out of the drum is not fit for use in hydraulic or lubrication systems.*

## Filtration Fact

*Additives in hydraulic fluid are generally well below 1 micron in size and are unaffected by standard filtration methods.*

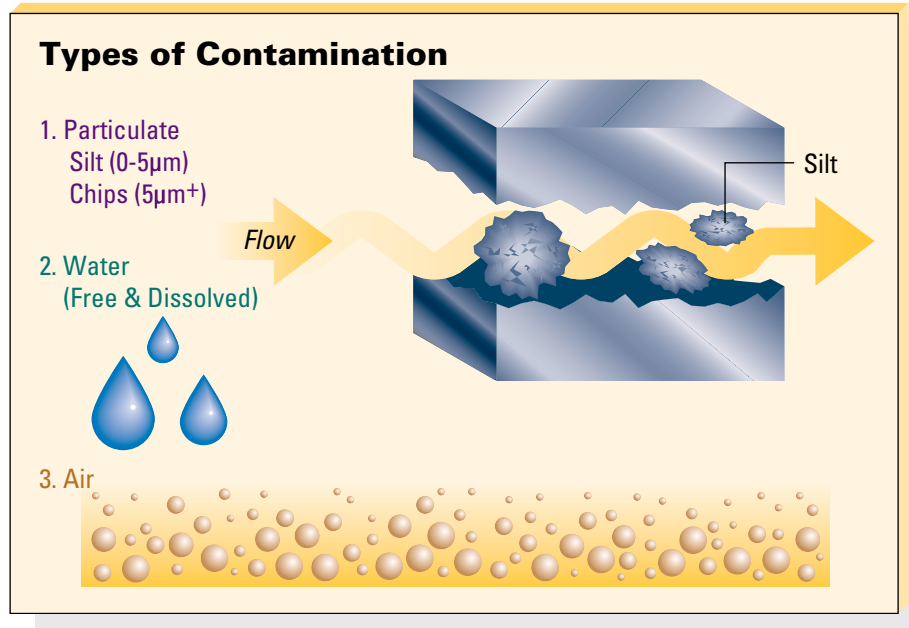

## Particulate Contamination

### Types

Particulate contamination is generally classified as “silt” or “chips.” Silt can be defined as the accumulation of particles less than 5µm over time. This type of contamination also causes system component failure over time. Chips on the other hand, are particles 5µm+ and can cause immediate catastrophic failure. Both silt and chips can be further classified as:

#### Hard Particles

- ▼ Silica
- ▼ Carbon
- ▼ Metal

#### Soft Particles

- ▼ Rubber
- ▼ Fibers
- ▼ Micro organism

# Contamination Types and Sources

## Damage

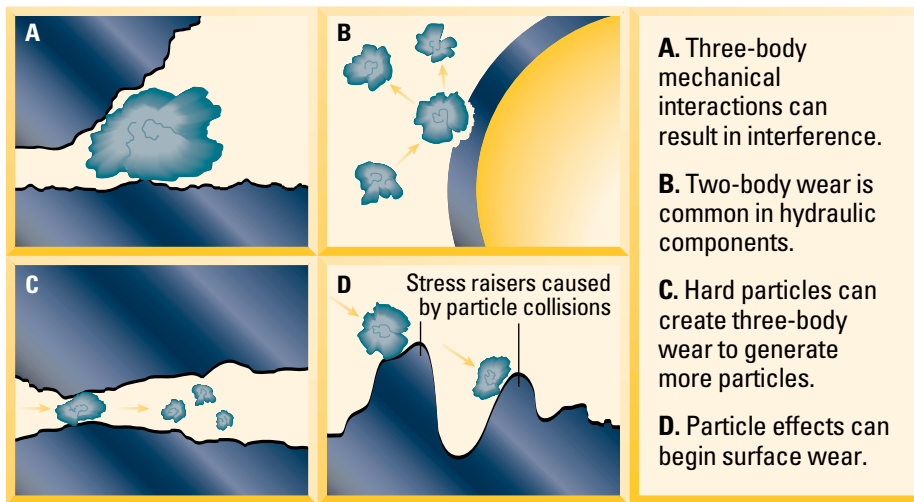

If not properly flushed, contaminants from manufacturing and assembly will be left in the system.

These contaminants include dust, welding slag, rubber particles from hoses and seals, sand from castings, and metal debris from machined components. Also, when fluid is initially added to the system, contamination is introduced.

During system operation, contamination enters through breather caps, worn seals, and other system openings. System operation also generates internal contamination. This occurs as component wear debris and chemical byproducts react with component surfaces to generate more contamination.

## Sources

- ▼ Built-in during manufacturing and assembly processes.
- ▼ Added with new fluid.
- ▼ Ingested from outside the system during operation.
- ▼ Internally generated during operation (see chart below).

## Generated Contamination

**Abrasive Wear**—Hard particles bridging two moving surfaces, scraping one or both.

**Cavitation Wear**—Restricted inlet flow to pump causes fluid voids that implode causing shocks that break away critical surface material.

**Fatigue Wear**—Particles bridging a clearance cause a surface stress riser that expands into a spall due to repeated stressing of the damaged area.

**Erosive Wear**—Fine particles in a high speed stream of fluid eat away a metering edge or critical surface.

**Adhesive Wear**—Loss of oil film allows metal to metal contact between moving surfaces.

**Corrosive Wear**—Water or chemical contamination in the fluid causes rust or a chemical reaction that degrades a surface.

## Filtration Fact

### System Contamination Warning Signals

- Solenoid burn-out.
- Valve spool decentering, leakage, "chattering".
- Pump failure, loss of flow, frequent replacement.
- Cylinder leakage, scoring.
- Increased servo hysteresis.

## Filtration Fact

Most system ingress enters a system through the old-style reservoir breather caps and the cylinder rod glands.

### External Contamination Sources

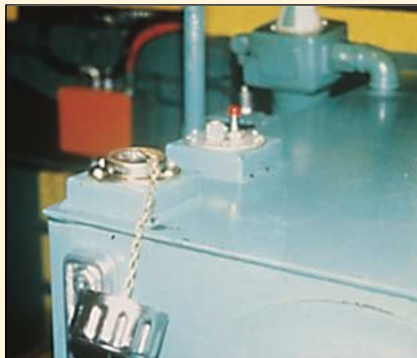

### Ingression Rates For Typical Systems

Mobile Equipment	$10^8$ - $10^{10}$ per minute*
Manufacturing Plants	$10^6$ - $10^8$ per minute*
Assembly Facilities	$10^5$ - $10^6$ per minute*

\* Number of particles greater than 10 microns ingressed into a system from all sources.

### Prevention

- ▼ Use spin-on or desiccant style filters for reservoir air breathers.
- ▼ Flush all systems before initial start-up.
- ▼ Specify rod wipers and replace worn actuator seals.
- ▼ Cap off hoses and manifolds during handling and maintenance.
- ▼ Filter all new fluid before it enters the reservoir.



# Contamination Types and Sources

## Water Contamination

### Types

There is more to proper fluid maintenance than just removing particulate matter. Water is virtually a universal contaminant, and just like solid particle contaminants, must be removed from operating fluids. Water can be either in a dissolved state or in a “free” state. Free, or emulsified, water is defined as the water above the saturation point of a specific fluid. At this point, the fluid cannot dissolve or hold any more water. Free water is generally noticeable as a “milky” discoloration of the fluid.

Typical Saturation Points		
Fluid Type	PPM	%
Hydraulic Fluid	300	.03%
Lubrication Fluid	400	.04%
Transformer Fluid	50	.005%

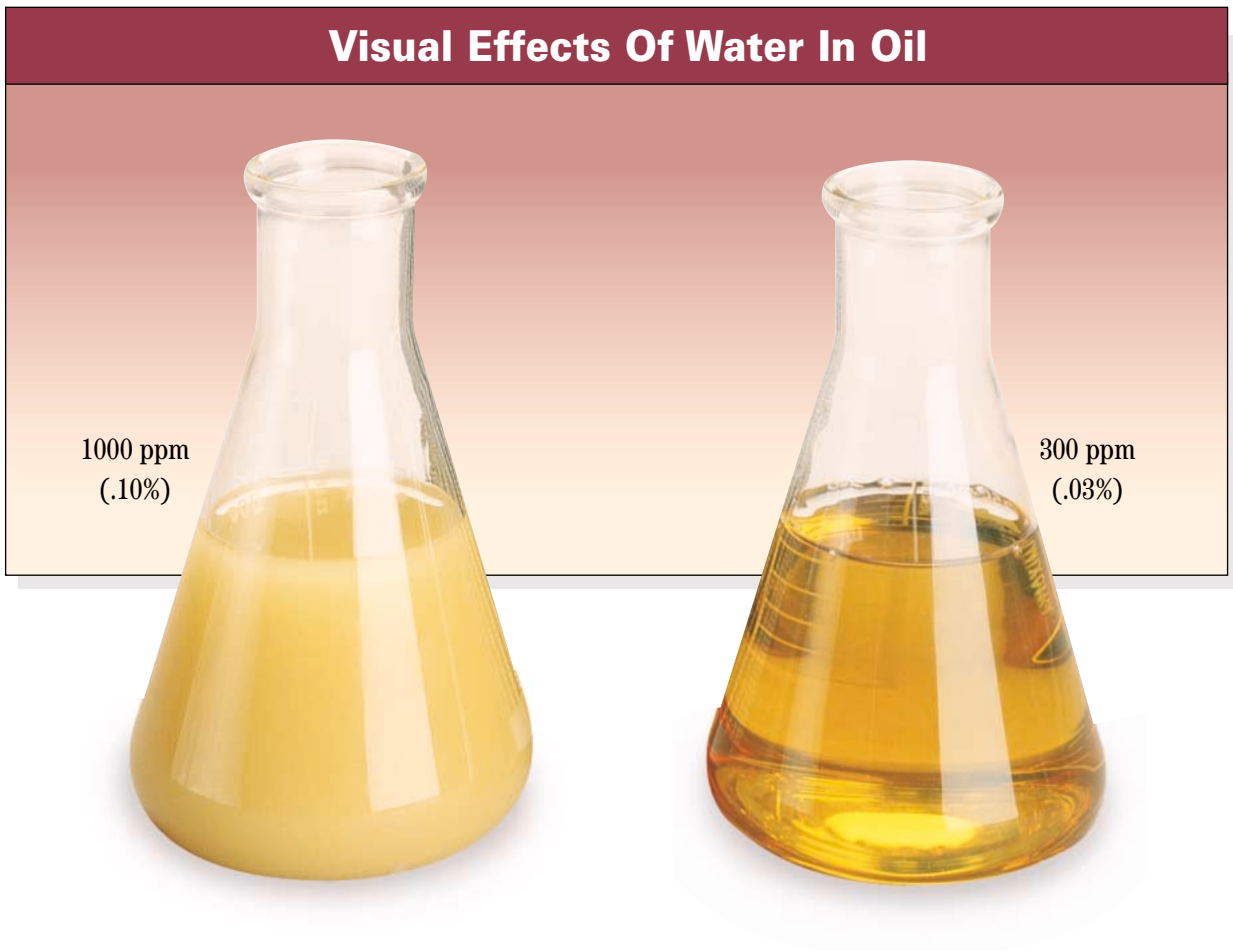



## Contamination Types and Sources

### Filtration Fact

***A simple 'crackle test' will tell you if there is free water in your fluid. Apply a flame under the container. If bubbles rise and 'crackle' from the point of applied heat, free water is present in the fluid.***

### Filtration Fact

***Hydraulic fluids have the ability to 'hold' more water as temperature increases. A cloudy fluid may become clearer as a system heats up.***

### Damage

- ▼ Corrosion of metal surfaces
- ▼ Accelerated abrasive wear
- ▼ Bearing fatigue
- ▼ Fluid additive breakdown
- ▼ Viscosity variance
- ▼ Increase in electrical conductivity

Anti-wear additives break down in the presence of water and form acids. The combination of water, heat and dissimilar metals encourages galvanic action. Pitted and corroded metal surfaces and finishes result. Further complications occur as temperature drops and the fluid has less ability to hold water. As the freezing point

is reached, ice crystals form, adversely affecting total system function. Operating functions may also become slowed or erratic.

Electrical conductivity becomes a problem when water contamination weakens the insulating properties of a fluid, thus decreasing its dielectric kV strength.



Typical results of pump wear due to particulate and water contamination

# Contamination Types and Sources

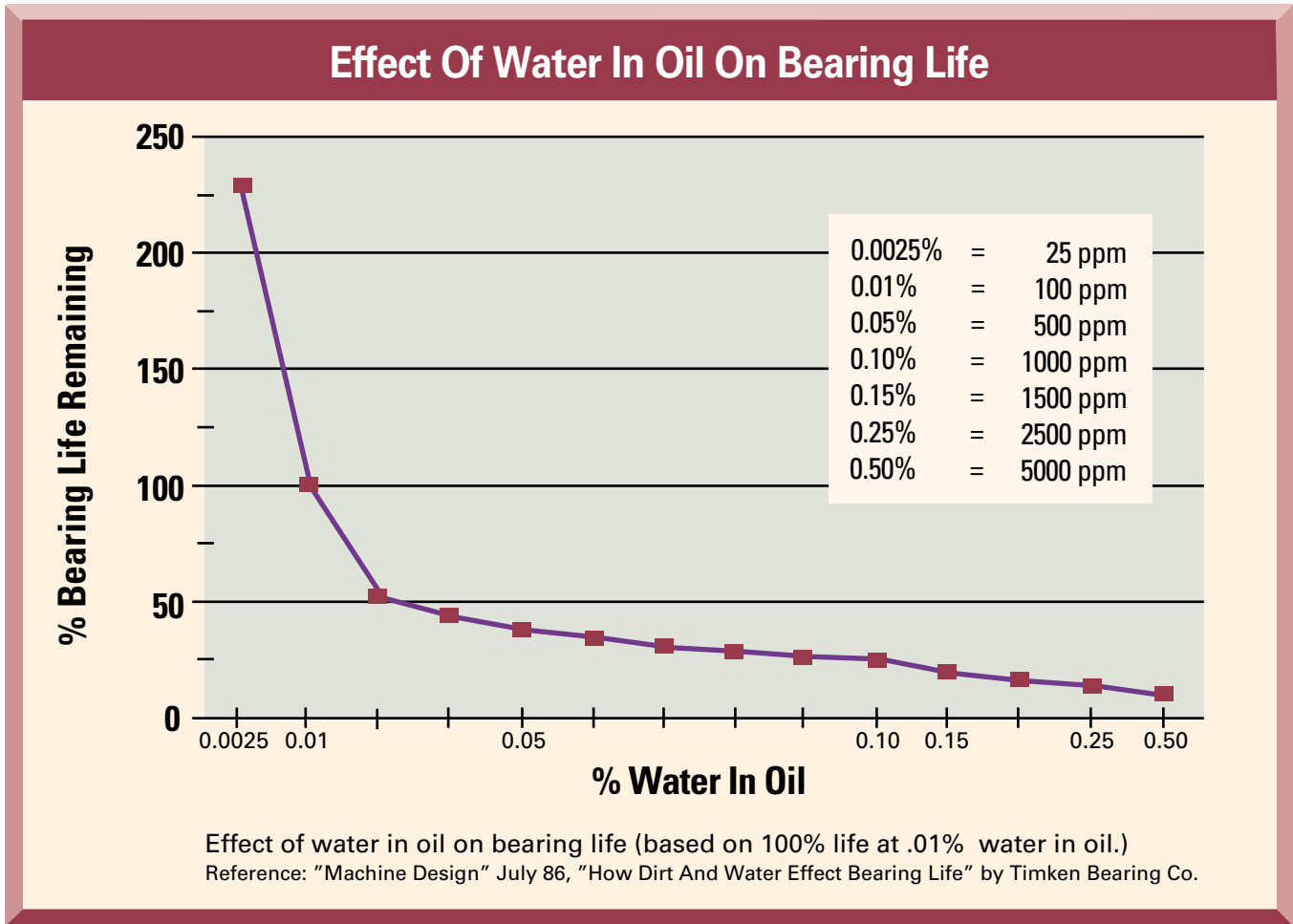

## Sources

- ▼ Worn actuator seals
- ▼ Reservoir opening leakage
- ▼ Condensation
- ▼ Heat exchanger leakage

Fluids are constantly exposed to water and water vapor while being handled and stored. For instance, outdoor storage of tanks and drums is common. Water may settle on top of fluid containers and be drawn into the container during temperature changes. Water may also be introduced when opening or filling these containers.

Water can enter a system through worn cylinder or actuator seals or through reservoir openings. Condensation is also a prime water source. As the fluids cool in a reservoir or tank, water vapor will condense on the inside surfaces, causing rust or other corrosion problems.





# Contamination Types and Sources

## Filtration Fact

**Free water is heavier than oil, thus it will settle to the bottom of the reservoir where much of it can be easily removed by opening the drain valve.**

## Filtration Fact

**Absorption filter elements have optimum performance in low flow and low viscosity applications.**

### Prevention

Excessive water can usually be removed from a system. The same preventative measures taken to minimize particulate contamination ingress in a system can be applied to water contamination. However, once excessive water is detected, it can usually be eliminated by one of the following methods:

### Absorption

This is accomplished by filter elements that are designed specifically to take out free water. They usually consist of a laminant-type material that transforms free water into a gel that is trapped within the element. These elements fit

into standard filter housings and are generally used when small volumes of water are involved.

### Centrifugation

Separates water from oil by a spinning motion. This method is also only effective with free water, but for larger volumes.

### Vacuum Dehydration

Separates water from oil through a vacuum and drying process. This method is also for larger volumes of water, but is effective with both the free and dissolved states.



Vacuum dehydration system



# Contamination Types and Sources

## Air Contamination

### Types

Air in a liquid system can exist in either a dissolved or entrained (undissolved, or free) state. Dissolved air may not pose a problem, providing it stays in solution. When a liquid contains undissolved air, problems can occur as it passes through system components. There can be pressure changes that compress the air and produce a large amount of heat in small air bubbles. This heat can destroy additives, and the base fluid itself.

If the amount of dissolved air becomes high enough, it will have a negative effect on the amount of work performed by the system. The work performed in a hydraulic system relies on the fluid being relatively incompressible, but air reduces the bulk modulus of the fluid. This is due to the fact that air is up to 20,000 times more compressible than a liquid in which it is dissolved. When air is present, a pump ends up doing more work to compress the air, and less useful work on the system. In this situation, the system is said to be 'spongy'.

### Damage

- ▼ Loss of transmitted power
- ▼ Reduced pump output
- ▼ Loss of lubrication
- ▼ Increased operating temperature
- ▼ Reservoir fluid foaming
- ▼ Chemical reactions

Air in any form is a potential source of oxidation in liquids. This accelerates corrosion of metal parts, particularly when water is also present. Oxidation of additives also may occur. Both processes produce oxides which promote the formation of particulates, or form a sludge in the liquid. Wear and interference increases if oxidation debris is not prevented or removed.

### Sources

- ▼ System leaks
- ▼ Pump aeration
- ▼ Reservoir fluid turbulence

### Prevention

- ▼ System air bleeds
- ▼ Flooded suction pump
- ▼ Proper reservoir design
- ▼ Return line diffusers



# Fluid Cleanliness Standards

## Filtration Fact

**Knowing the cleanliness level of a fluid is the basis for contamination control measures.**

## Filtration Fact

**The ISO code index numbers can never increase as the particle sizes increase (Example: 18/20/22). All particle distributions have more smaller than larger particles.**

In order to detect or correct problems, a contamination reference scale is used. Particle counting is the most common method to derive cleanliness level standards. Very sensitive optical instruments are used to count the number of particles in various size ranges. These counts are reported as the number of particles greater than a certain size found in a specified volume of fluid.

The ISO 4406:1999 (International Standards Organization) cleanliness level standard has gained wide acceptance in most industries today. This standard references the number of particles greater than 4, 6, and 14 micrometers in a known volume, usually 1 milliliter or 100 milliliters. The number of 4+ and 6+ micrometer particles is used as a reference point for "silt" particles. The 14+ size range indicates the quantity of larger particles present which contribute greatly to possible catastrophic component failure.

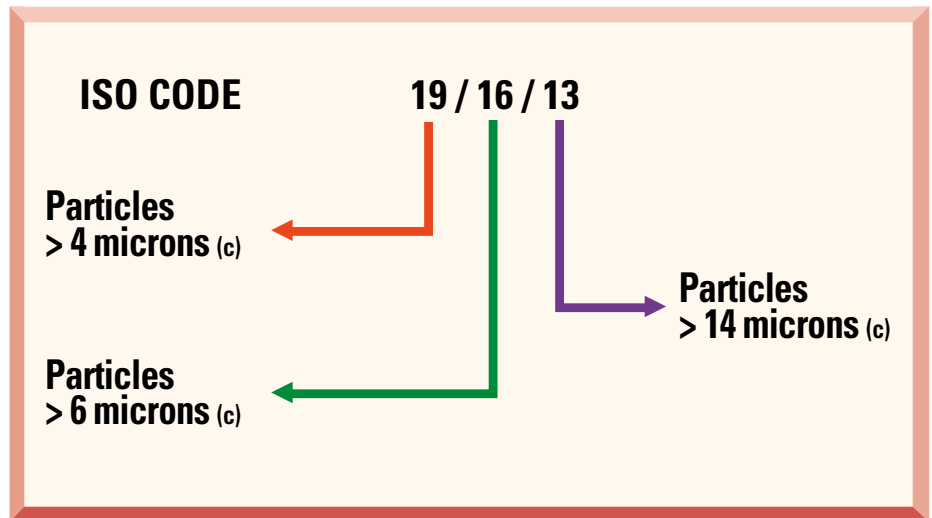

An ISO classification of 19/16/13 can be defined as:

Range Number	Micron (c)	Actual Particle Count Range (per ml)
19	4+	2,500 - 5,000
16	6+	320 - 640
13	14+	40 - 80

# Fluid Cleanliness Standards

ISO 4406 Chart		
Range Number	Number of particles per ml	
	More than	Up to and including
24	80,000	160,000
23	40,000	80,000
22	20,000	40,000
21	10,000	20,000
20	5,000	10,000
19	2,500	5,000
18	1,300	2,500
17	640	1,300
16	320	640
15	160	320
14	80	160
13	40	80
12	20	40
11	10	20
10	5	10
9	2.5	5
8	1.3	2.5
7	.64	1.3
6	.32	.64

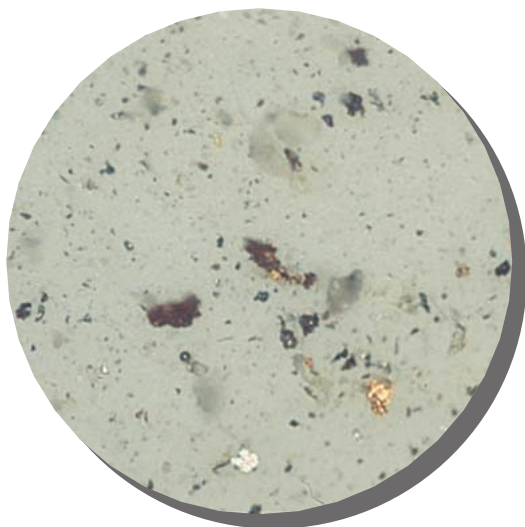

ISO 22/19/17 fluid (magnification 100x)

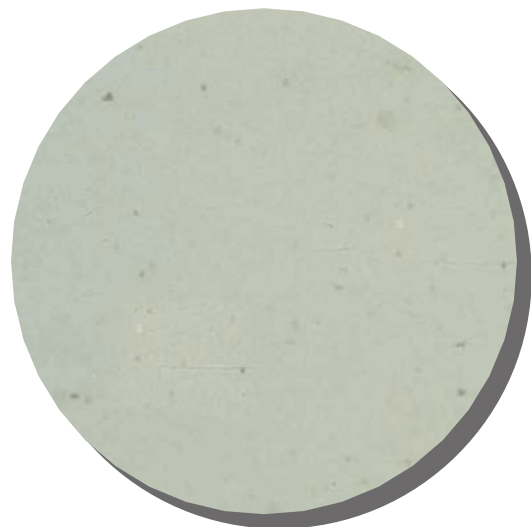

ISO 17/14/11 fluid (magnification 100x)



# Fluid Cleanliness Standards

## Filtration Fact

**Most machine and hydraulic component manufacturers specify a target ISO cleanliness level to equipment in order to achieve optimal performance standards.**

## Filtration Fact

**Color is not a good indicator of a fluid's cleanliness level.**

### Component Cleanliness Level Requirements

Many manufacturers of hydraulic and load bearing equipment specify the optimum cleanliness level required for their components. Subjecting components to fluid with higher contamination levels may result in much shorter component life.

In the table below, a few components and their recommended cleanliness levels are shown. It is always best to consult with component manufacturers and obtain their written fluid cleanliness level recommendations. This information is needed in order to select the proper level of filtration.

It may also prove useful for any subsequent warranty claims, as it may draw the line between normal use and excessive or abusive operation.

### Fluid Cleanliness Required for Typical Hydraulic Components

Components	ISO Code
Servo control valves	17/14/11
Proportional valves	18/15/12
Vane and piston pumps/motors	19/16/13
Directional & pressure control valves	19/16/13
Gear pumps/motors	20/17/14
Flow control valves, cylinders	21/18/15
New unused fluid	21/18/15



# Fluid Cleanliness Standards

SAE AS5049 Revision E (Table 1)						
Cleanliness Classes For Differential Particle Counts (Particles / 100 mL) (3)						
Classes	(1)	5 to 15 $\mu\text{m}$	15 to 25 $\mu\text{m}$	25 to 50 $\mu\text{m}$	50 to 100 $\mu\text{m}$	>100 $\mu\text{m}$
	(2)	6 to 14 $\mu\text{m(c)}$	14 to 21 $\mu\text{m(c)}$	21 to 38 $\mu\text{m(c)}$	38 to 70 $\mu\text{m(c)}$	>70 $\mu\text{m(c)}$
00		125	22	4	1	0
0		250	44	8	2	0
1		500	89	16	3	1
2		1 000	178	32	6	1
3		2 000	356	63	11	2
4		4 000	712	126	22	4
5		8 000	1 425	253	45	8
6		16 000	2 850	506	90	16
7		32 000	5 700	1 012	180	32
8		64 000	11 400	2 025	360	64
9		128 000	22 800	4 050	720	128
10		256 000	45 600	8 100	1 440	256
11		512 000	91 200	16 200	2 880	512
12		1 024 000	182 400	32 400	5 760	1 024

(1) Size Range, Optical Microscope, based on longest dimension as measured per ARP598, APC Calibrated per ISO 4402:1991.

(2) Size Range, APC Calibrated Per ISO 11171 or Electron Microscope, based on projected area equivalent diameter.

(3) Classes and contamination limits identical to NAS 1638.



## Filter Media Types and Ratings

### Filtration Fact

**Surface media can be cleaned and re-used. An ultrasonic cleaner is usually the best method. Depth media typically cannot be cleaned and it is not re-usable.**

*The filter media is that part of the element which removes the contaminant.*

Media usually starts out in sheet form, and is then pleated to expose more surface area to the fluid flow. This reduces pressure differential while increasing dirt holding capacity. In some cases, the filter media may have multiple layers and mesh backing to achieve certain performance criteria. After being pleated and cut to the proper length, the two ends are fastened together using a special clip, adhesive, or other seaming mechanism. The most common media include wire mesh, cellulose, fiberglass composites, or other synthetic materials. Filter media is generally classified as either *surface* or *depth*.

#### Surface Media

For surface type filter media, the fluid stream basically has a straight through flow path. Contaminant is captured on the surface of the element which faces the fluid flow. Surface type elements are generally made from woven wire. Since the process used in manufacturing the wire cloth can be very accurately controlled, surface type media have a consistent pore size. This consistent pore size is the diameter of the largest hard spherical particle that will pass through the media under specified test conditions. However, the build-up of contaminant on the element surface will allow the media to capture particles smaller than the pore size rating. Likewise, particles that have a smaller diameter, but may be longer in length (such as a fiber strand), may pass downstream of a surface media.

#### Depth Media

For depth type filter media, fluid must take indirect paths through the material which makes up the filter media. Particles are trapped in the maze of openings throughout the media. Because of its construction, a depth type filter media has many pores of various sizes. Depending on the distribution of pore sizes, this media can have a very high capture rate at very small particle sizes.

The nature of filtration media and the contaminant loading process in a filter element explains why some elements last much longer than others. In general, filter media contain millions of tiny pores formed by the media fibers. The pores have a range of different sizes and are interconnected throughout the layer of the media to form a tortuous path for fluid flow.

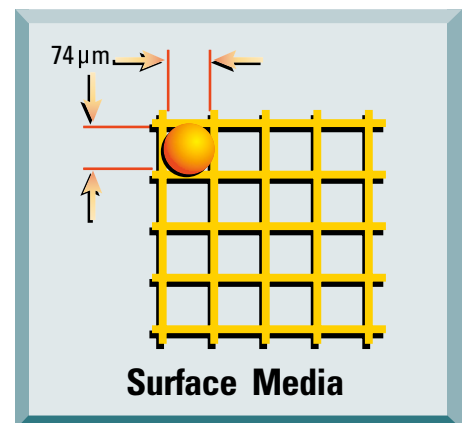

# Filter Media Types and Ratings

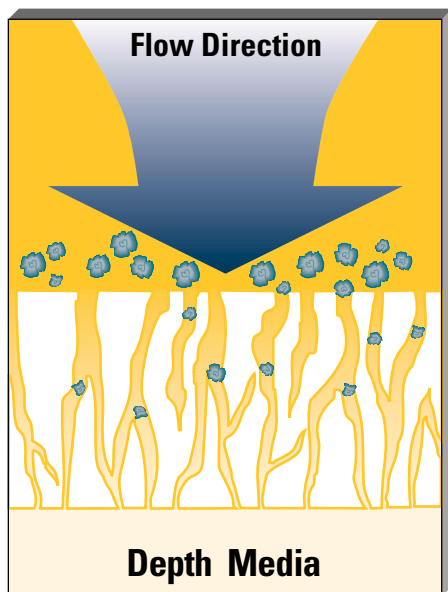

The two basic depth media types that are used for filter elements are cellulose and fiberglass.

The pores in cellulose media tend to have a broad range of sizes due to the irregular size and shape of the fibers. In contrast, fiberglass media consist of fibers that are very uniform in size and shape. The fibers are generally thinner than cellulose fibers, and have a uniform circular cross section. These typical fiber differences account for the performance advantage of fiberglass media. Thinner fibers mean more actual pores in a given space. Furthermore, thinner fibers can be arranged closer together to produce smaller pores for finer filtration. Dirt holding capacity, as well as filtration efficiency, are improved as a result.

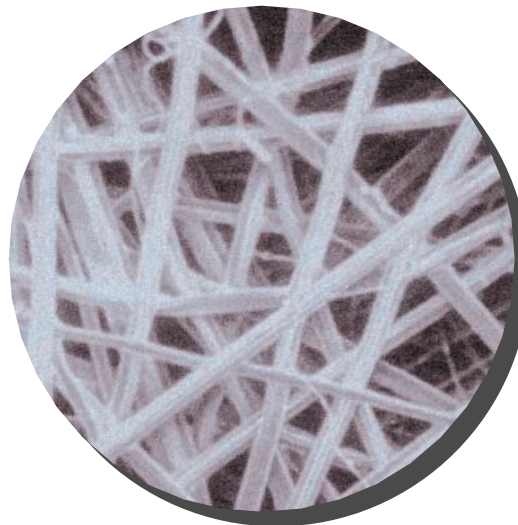

Typical coarse fiberglass construction (100X)

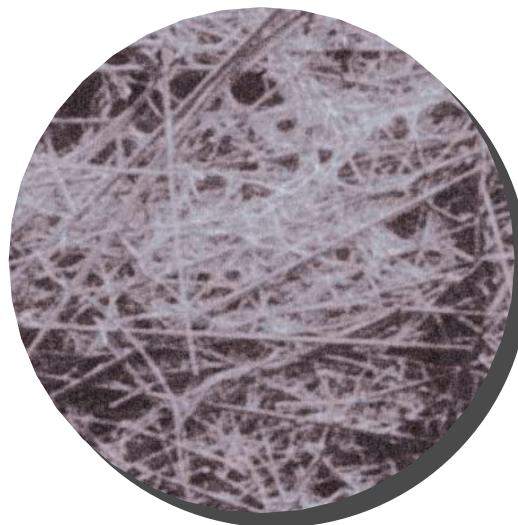

Typical fine fiberglass construction (100X)

## General Comparison Of Filter Media

Media Material	Capture Efficiency	Dirt Holding Capacity	Differential Pressure	Life In a System	Initial Cost
Fiberglass	High	High	Moderate	High	Moderate
Cellulose (paper)	Moderate	Moderate	High	Moderate	Low
Wire Mesh	Low	Low	Low	Moderate	High



# Filter Media Types and Ratings

## Filtration Fact

**Filter media ratings expressed as a Beta Ratio indicate a media's particle removal efficiency.**

## Filtration Fact

**Multipass test results are very dependent on the following variables:**

- **Flow rate**
- **Terminal pressure differential**
- **Contaminant type**

### The Multipass Test

The filtration industry uses the ISO 4572 "Multipass Test Procedure" to evaluate filter element performance. This procedure is also recognized by ANSI\* and NFPA\*\*.

During the Multipass Test, fluid is circulated through the circuit under precisely controlled and monitored conditions. The differential pressure across the test element is continuously recorded, as a constant amount of contaminant is injected upstream of the element. On-line laser particle sensors determine the contaminant levels upstream and downstream of the test element. This performance attribute (The Beta Ratio) is determined for several particle sizes.

Three important element performance characteristics are a result of the Multipass Test:

1. Dirt holding capacity.
2. Pressure differential of the test filter element.
3. Separation or filtration efficiency, expressed as a "Beta Ratio".

### Beta Ratio

The Beta Ratio (also known as the filtration ratio) is a measure of the particle capture efficiency of a filter element. It is therefore a performance rating.

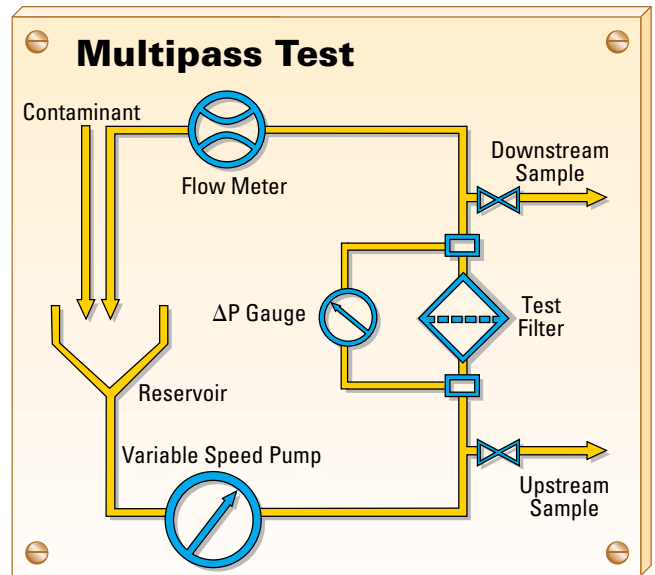

As an example of how a Beta Ratio is derived from a Multipass Test. Assume that 50,000 particles, 10 micrometers and larger, were counted upstream (before) of the test filter and 10,000 particles at that same size range were counted downstream (after) of the test filter. The corresponding Beta Ratio would equal 5, as seen in the following example:

$$B_x = \frac{\text{\# of particles upstream}}{\text{\# of particles downstream}}$$

"x" is at a specific particle size

$$B_{10} = \frac{50,000}{10,000} = 5$$

\* ANSI – American National Standards Institute  
 \*\* NFPA – National Fluid Power Association



# Filter Media Types and Ratings

The example would read “Beta ten equal to five.” Now, a Beta Ratio number alone means very little. It is a preliminary step to find a filter’s particle capture efficiency. This efficiency, expressed as a percent, can be found by a simple equation:

$$\text{Efficiency}_x = \left(1 - \frac{1}{\text{Beta}}\right) 100$$

$$\begin{aligned} \text{Efficiency}_{10} &= \left(1 - \frac{1}{5}\right) 100 \\ &= 80\% \end{aligned}$$

So, in the example, the particular filter tested was 80% efficient at removing 10 micrometer and larger particles. For every 5 particles introduced to the filter at this size range, 4 were trapped in the filter media. The Beta Ratio/ Efficiencies table shows some common Beta Ratio numbers and their corresponding efficiencies.

Beta Ratios/Efficiencies	
Beta Ratio (at a given particle size)	Capture Efficiency (at same particle size)
1.01	1.0%
1.1	9.0%
1.5	33.3%
2.0	50.0%
5.0	80.0%
10.0	90.0%
20.0	95.0%
75.0	98.7%
100	99.0%
200	99.5%
1000	99.9%

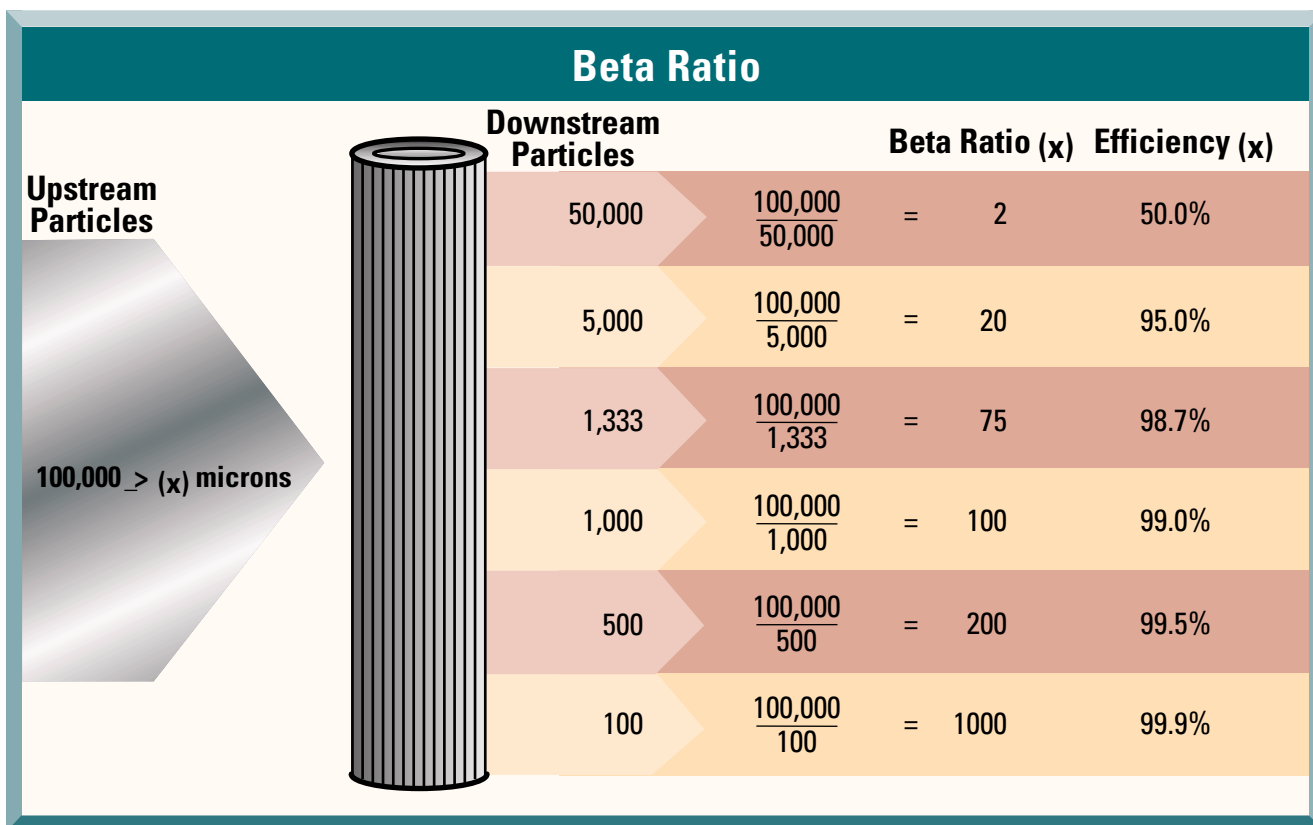



## Filter Media Selection

### Filtration Fact

***There is no direct correlation between using a specific media and attaining a specific ISO cleanliness classification. Numerous other variables should be considered, such as particulate ingress, actual flow through filters, and filter locations.***

A number of interrelated system factors combine to determine proper media and filter combinations. To accurately determine which combination is ideal for your system all these factors need to be accounted for. With the development of filtration sizing software such as inPHorm, this information can be used to compute the optimal selection. However, in many instances the information available may be limited. In these cases “rules of thumb”, based on empirical data and proven examples, are applied to try and get an initial starting point.

The charts on the following pages are designed for just those instances. Be aware that rules of thumb utilize “standard” values when looking at components, ingressions, and other system parameters. Your specific system may or may not fit into this “standard” classification.

One of the more important points of the charts is to emphasize element efficiency. Note that as less efficient elements are utilized, more passes are required to obtain the same ISO

cleanliness level as a more efficient element. Secondly, the charts indicate the effect of system pressure on the required ISO code. As system pressure increases, the oil film thickness between component parts decreases. This reduction in clearance allows smaller micron particles to have harmful effects. The charts attempt to provide flexibility by providing several possible solutions for each component/system pressure combination.

Selection software such as inPHorm (shown left) can be an extremely useful tool in the selection and specification of the proper filtration product. With computer aided selection, the user can quickly determine the pressure loss across a given element, and/or housing combination, within specific operating parameters. The tedious process of plotting viscosity at various points and calculating a pressure drop is eliminated. Additionally, selection software can predict system performance and element life – ideal for predictive maintenance programs.

#### How to use charts:

1. Choose the appropriate chart for your system, hydraulic or lubrication.
2. Starting in the left column, the components are listed by order of sensitivity. Find the most sensitive component used in your system.
3. Following the color band to the right of the component selected, choose the pressure range that the system operates within. This step is not required for lubrication systems.
4. Follow the color band to the right of the pressure range selected for the suggested ISO code for the system
5. To the right of the ISO code, in the same color band, are the media efficiencies required for the corresponding filter placements. Depending on the selection there will be one to three options available.
6. Be sure that the filter placements recommendation is on the same level as the media efficiency selected.

# Filter Media Selection

P = Full flow pressure filter (equals one filtration placement)

R = Full flow return filter (equals one filtration placement)

O = Off-line (flow rate 10% of reservoir volume equals .5 of a filtration placement)

\* Number of filtration placements in system, more placements are the option of the specifier.

Lubrication Systems				
Component Type	Suggested Cleanliness Code	Media Efficiency Beta <sub>x</sub> >200	Number of Filter Placements*	Minimum Filter Placements
Ball Bearings	16/13/11	2	1.5	P or R, & O
		2	1	P or R
Roller Bearings	17/14/12	5	2	P & R
		2	0.5	0
Journal Bearings Gear Boxes	18/15/13	5	1.5	P or R, & O
		10	2.5	P, R & O

Hydraulic Systems					
Component Type	System Pressure	Suggested Cleanliness Code	Media Efficiency Beta <sub>x</sub> >200	Number of Filter Placements	Minimum Filter Placements
Servo Valves	<1000	17/14/12	2	1	P
			5	2	P & R
	1000-3000	16/13/11	2	1.5	P & O
			2	2	P & R
Proportional Valves	<1000	18/15/13	2	1	P
			5	1.5	P & O
			10	2.5	P, R & O
	1000-3000	18/14/12	2	1	P
			5	2	P & R
	>3000	17/14/11	2	1.5	P & O
			5	2.5	P, R & O
			2	2	P & R
Variable Volume Pumps	<1000	19/16/14	5	1	P or R
			10	2	P & R
	1000-3000	18/16/14	2	0.5	O
			5	1.5	P or R, & O
	>3000	18/15/13	10	2.5	P, R & O
			2	1	P or R
Vane Pumps Fixed Piston Pumps Cartridge Valves	<1000	20/17/15	5	0.5	O
			10	1.5	P or R, & O
	1000-3000	19/17/14	5	1	P or R
			10	2	P & R
	>3000	19/16/13	5	1.5	P or R, & O
			10	2.5	P, R & O
Gear Pumps Flow Controls Cylinders	<1000	21/18/16	10	1	P or R
			20	2.5	P, R & O
	1000-3000	20/17/15	10	1.5	P or R, & O
			5	0.5	O
>3000	20/17/14	10	1.5	P or R, & O	



## Filtration Fact

***As an element loads with contamination, the differential pressure will increase over time; slowly at first, then very quickly as the element nears its maximum life.***

### Contaminant Loading

Contaminant loading in a filter element is simply the process of blocking the pores throughout the element. As the filter element becomes blocked with contaminant particles, there are fewer pores for fluid flow, and the pressure required to maintain flow through the media increases. Initially, the differential pressure across the element increases very slowly because there is an abundance of media pores for the fluid to pass through, and the pore blocking process has little effect on the overall pressure loss. However, a point is reached at which successive blocking of media pores significantly reduces the number of available pores for flow through the element. At this point the differential pressure across the element rises exponentially. The quantity, size, shape and arrangement of the pores throughout the

element accounts for why some elements last longer than others.

For a given filter media thickness and filtration rating, there are fewer pores with cellulose media than fiberglass media. Accordingly, the contaminant loading process would block the pores of the cellulose media element quicker than the identical fiberglass media element.

The multilayer fiberglass media element is relatively unaffected by contaminant loading for a longer time. The element selectively captures the various size particles, as the fluid passes through the element. The very small pores in the media are not blocked by large particles. These downstream small pores remain available for the large quantity of very small particles present in the fluid.

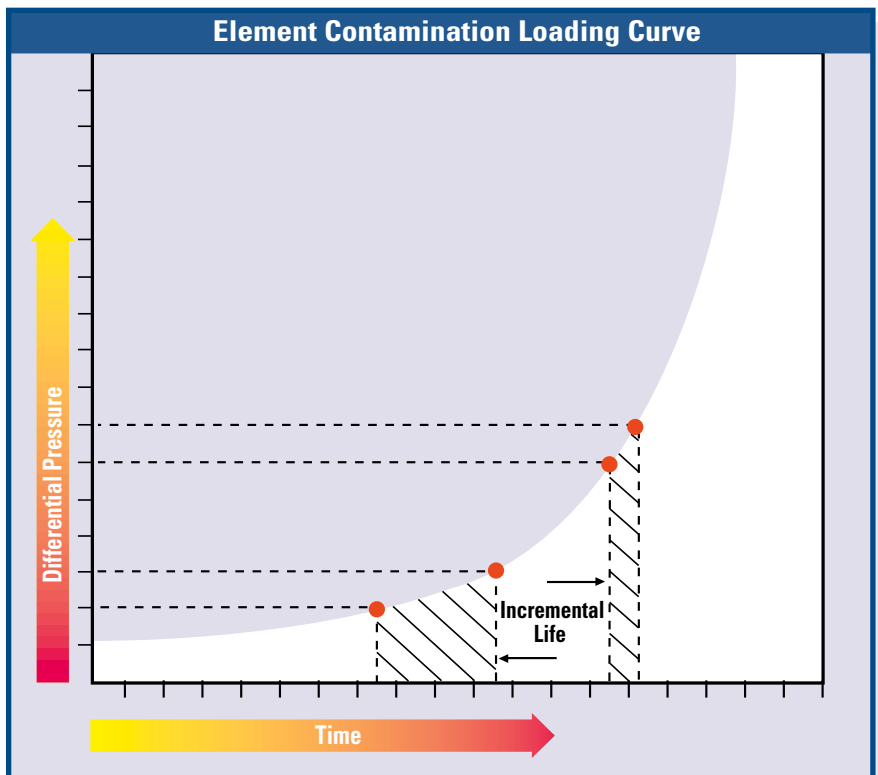



# Filter Element Life

## Filter Element Life Profile

Every filter element has a characteristic pressure differential versus contaminant loading relationship. This relationship can be defined as the “filter element life profile.” The actual life profile is obviously affected by the system operating conditions. Variations in the system flow rate and fluid viscosity affect the clean pressure differential across the filter element and have a well-defined effect upon the actual element life profile.

The filter element life profile is very difficult to evaluate in actual operating systems. The system operating versus idle time, the duty cycle and the changing ambient contaminant conditions all affect the life profile of the filter element. In addition, precise

instrumentation for recording the change in the pressure loss across the filter element is seldom available. Most machinery users and designers simply specify filter housings with differential pressure indicators to signal when the filter element should be changed.

The Multipass Test data can be used to develop the pressure differential versus contaminant loading relationship, defined as the filter element life profile. As previously mentioned, such operating conditions as flow rate and fluid viscosity affect the life profile for a filter element. Life profile comparisons can only be made when these operating conditions are identical and the filter elements are the same size.

Then, the quantity, size, shape, and arrangement of the pores in the filter element determine the characteristic life profile. Filter elements that are manufactured from cellulose media, single layer fiberglass media and multi-layer fiberglass media all have a very different life profile. The graphic comparison of the three most common media configurations clearly shows the life advantage of the multilayer fiberglass media element.

## Element Types Life Comparison

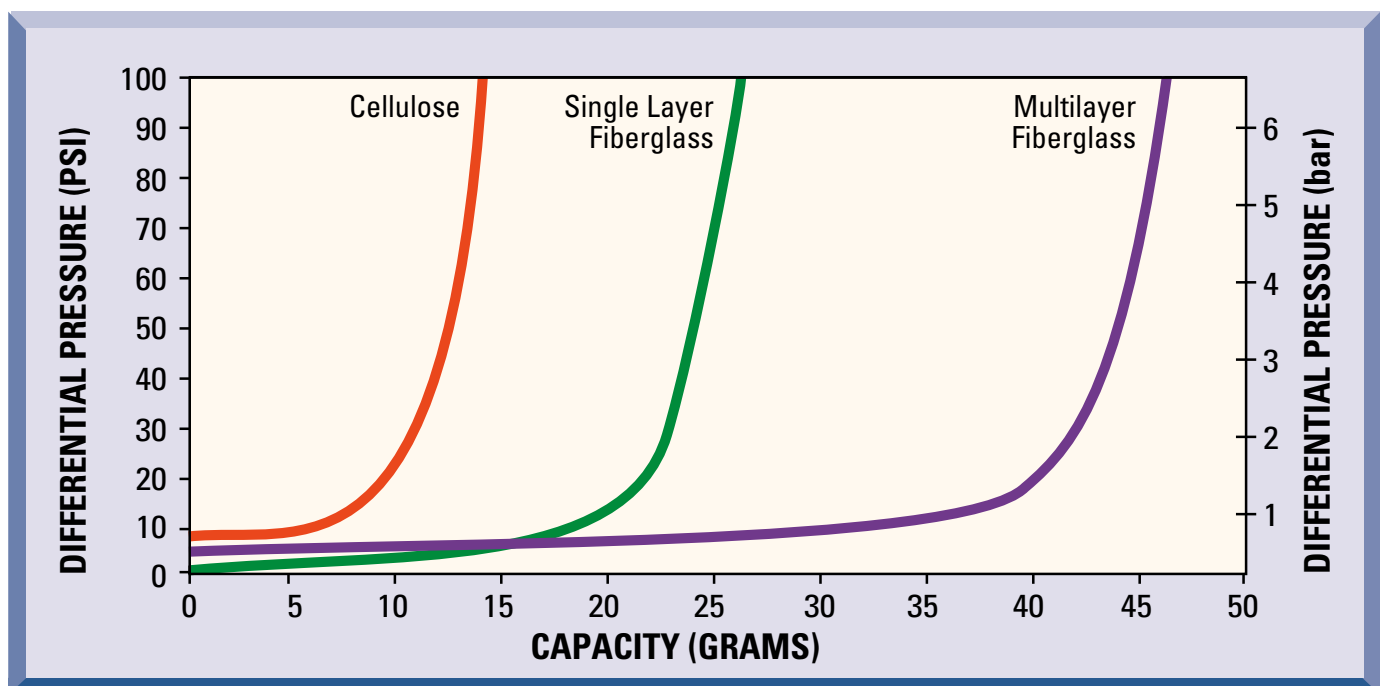



# Filter Housing Selection

## Filtration Fact

**Always use an element condition indicator with any filter, especially those that do not have a bypass valve.**

## Filtration Fact

**An element loading with contaminant will continue to increase in pressure differential until either:**

- The element is replaced.
- The bypass valve opens.
- The element fails.

### Filter Housings

The filter housing is the pressure vessel which contains the filter element. It usually consists of two or more sub-assemblies, such as a head (or cover) and a bowl to allow access to the filter element. The housing has inlet and outlet ports allowing it to be installed into a fluid system. Additional housing features may include mounting holes, bypass valves and element condition indicators.

### Pressure Ratings

Location of the filter in the circuit is the primary determinant of pressure rating. Filter housings are generically designed for three locations in a circuit: suction, pressure, or return lines. One characteristic of these locations is their maximum operating pressures. Suction and return line filters are generally designed for lower pressures up to 500 psi (34 bar). Pressure filter

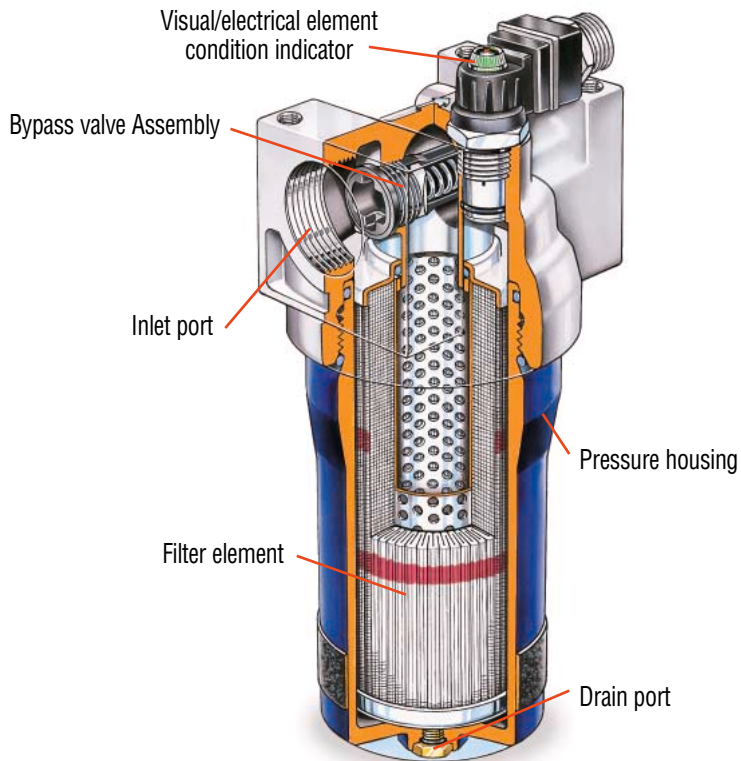

The primary concerns in the housing selection process include mounting methods, porting options, indicator options, and pressure rating. All, except the pressure rating, depend on the physical system design and the preferences of the designer. Pressure rating of the housing is far less arbitrary. This should be determined before the housing style is selected.

locations may require ratings from 1500 psi to 6000 psi (103 bar to 414 bar). It is essential to analyze the circuit for frequent pressure spikes as well as steady state conditions. Some housings have restrictive or lower fatigue pressure ratings. In circuits with frequent high pressure spikes, another type housing may be required to prevent fatigue related failures.

# Filter Housing Selection

## The Bypass Valve

The bypass valve is used to prevent the collapse or burst of the filter element when it becomes highly loaded with contaminant. It also prevents pump cavitation in the case of suction line filtration. As contaminant builds up in the element, the differential pressure across the element increases. At a pressure well below the failure point of the filter element, the bypass valve opens, allowing flow to go around the element.

Some bypass valve designs have a “bypass to-tank” option. This allows the unfiltered bypass flow to return to tank through a third port, preventing unfiltered bypass flow from entering the system. Other filters may be supplied

with a “no bypass” or “blocked” bypass option. This prevents any unfiltered flow from going downstream. In filters with no bypass valves, higher collapse strength elements may be required, especially in high pressure filters. Applications for using a “no bypass” option include servo valve and other sensitive component protection. When specifying a non-bypass filter design, make sure that the element has a differential pressure rating close to maximum operating pressure of the system. When specifying a bypass type filter, it can generally be assumed that the manufacturer has designed the

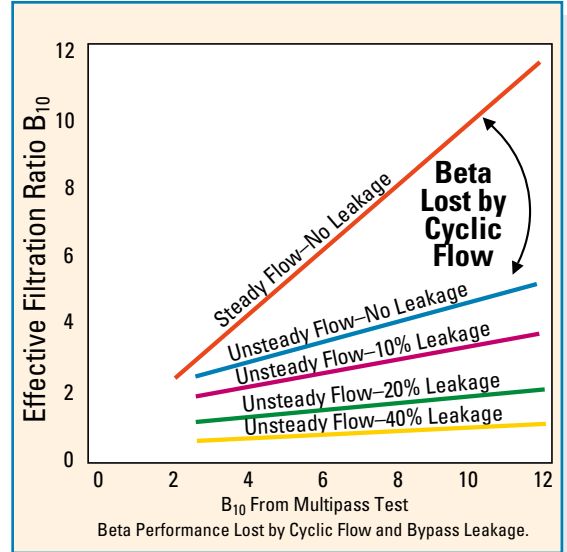

element to withstand the bypass valve differential pressure when the bypass valve opens.

After a housing style and pressure rating are selected, the bypass valve setting needs to be chosen. The bypass valve setting must be selected before sizing a filter housing. Everything else being equal, the highest bypass cracking pressure available from the manufacturer should be selected. This will provide the longest element life for a given filter size. Occasionally, a lower setting may be selected to help minimize energy loss in a system, or to reduce back-pressure on another component. In suction filters, either a 2 or 3 psi (0.14 bar or 0.2 bar) bypass valve is used to minimize the chance of potential pump cavitation.

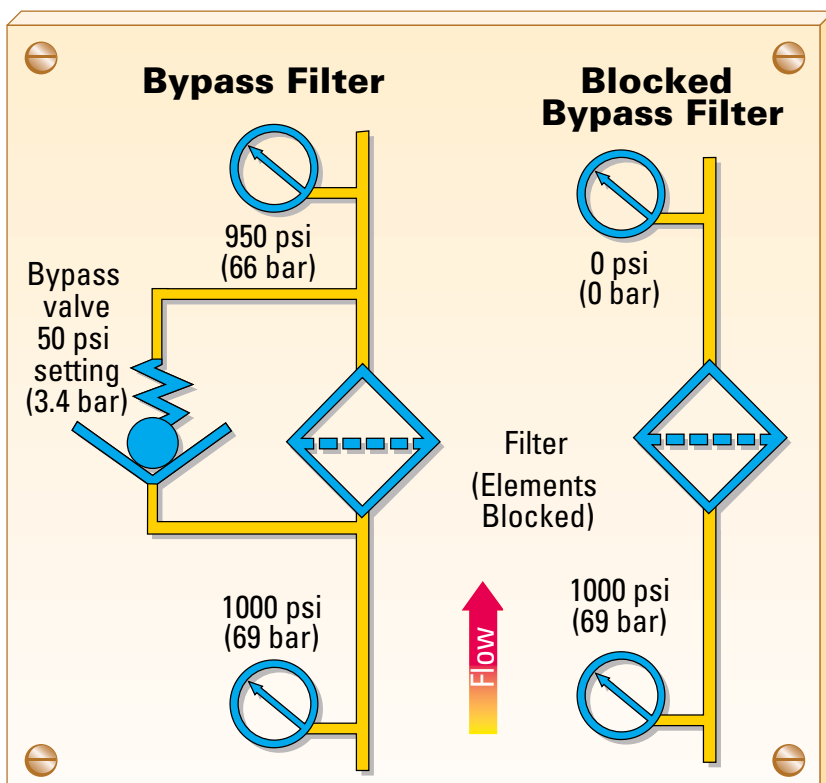



# Filter Housing Selection

## Filtration Fact

*Always consider low temperature conditions when sizing filters. Viscosity increases in the fluid may cause a considerable increase in pressure differential through the filter assembly.*

## Filtration Fact

*Pressure differential in a filter assembly depends on:*

1. Housing and element size
2. Media grade
3. Fluid viscosity
4. Flow rate

## Filtration Fact

*It is recommended to use an element condition indicator with any filter, especially those that do not incorporate a bypass valve.*

### Element Condition Indicators

The element condition indicator signals when the element should be cleaned or replaced. The indicator usually has calibration marks which also indicates if the filter bypass valve has opened. The indicator may be mechanically linked to the bypass valve, or it may be an entirely independent differential pressure sensing device. Indicators may give visual, electrical or both types of signals. Generally, indicators are set to trip anywhere from 5%-25% before the bypass valve opens.



### Housing And Element Sizing

The filter housing size should be large enough to achieve at least a 2:1 ratio between the bypass valve setting and the pressure differential of the filter with a clean element installed. It is preferable that this ratio be 3:1 or even higher for longer element life.

For example, the graph on the next page illustrates the type of catalog flow/pressure differential curves which are used to size the filter housing. As can be seen, the specifier needs to know the operating viscosity of the fluid, and the maximum flow rate (instead of an average) to make sure that the filter does not spend a high portion of time in bypass due to flow surges. This is particularly important in return line filters, where flow multiplication from cylinders may increase the return flow compared to the pump flow rate.

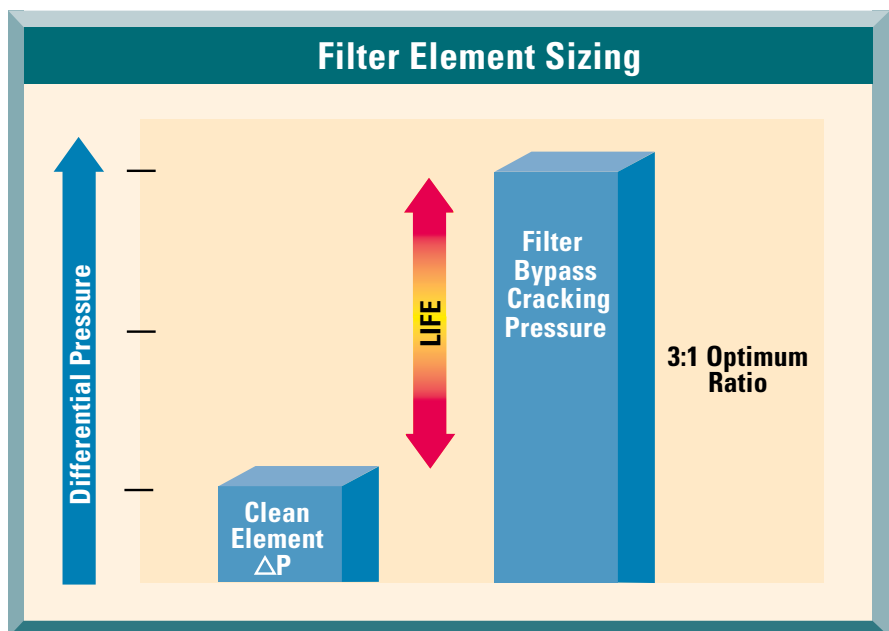



# Filter Housing Selection

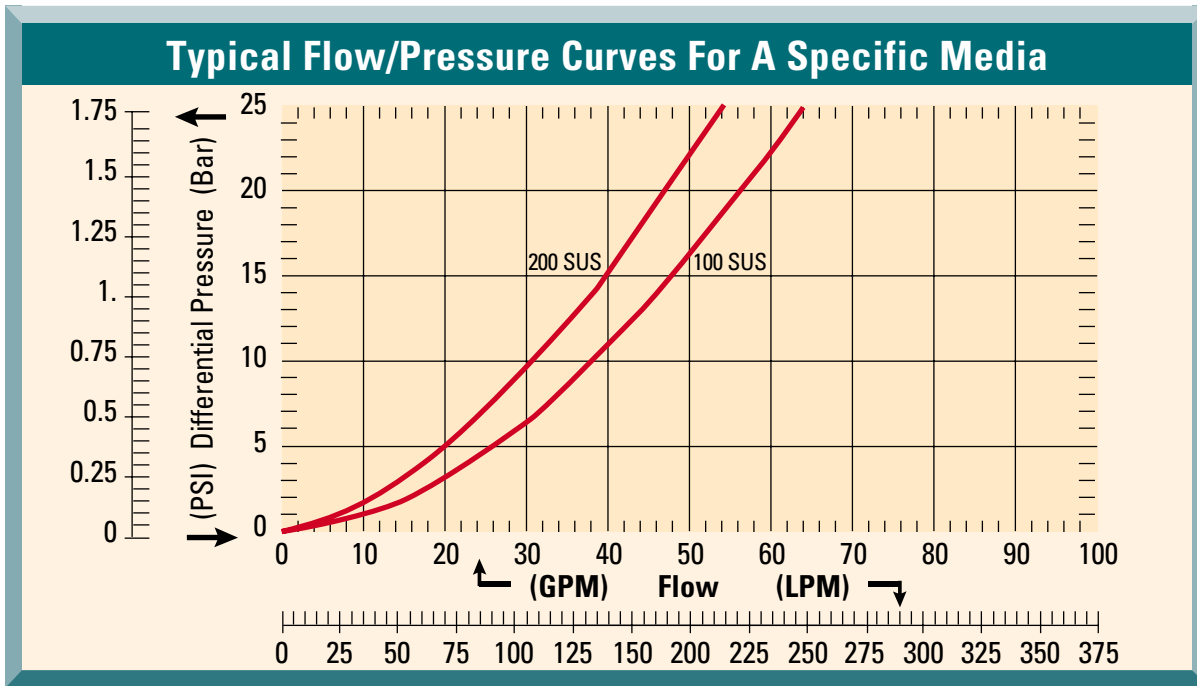

If the filter described in the graph was fitted with a 50 psi (3.4 bar) bypass valve the initial (clean) pressure differential should be no greater than 25 psi (1.7 bar) and preferably 16 <sup>2</sup>/<sub>3</sub> psi (1.1 bar) or less. This is calculated from the 3:1 and 2:1 ratio of bypass setting and initial pressure differential.

### 3:1 RATIO

▼  $50/3 = 16 \frac{2}{3}$  psid (1.1 bar)

### 2:1 RATIO

▼  $50/2 = 25$  psid (1.7 bar)

▼ At 200 sus fluid, the maximum flow range would be between 42 gpm and 54 gpm (159 lpm and 204 lpm)

Most standard filter assemblies utilize a bypass valve to limit the maximum pressure drop across the filter element. As the filter element becomes blocked with contaminant, the pressure differential increases until the bypass valve cracking pressure is reached. At this point, the flow through the filter assembly begins bypassing the filter element and passes through the bypass valve. This action limits the maximum pressure differential across the filter element. The important issue is that some of the system contaminant particles also bypass the filter element. When this happens, the effectiveness of the filter element is compromised and the attainable system fluid cleanliness degrades. Standard filter assemblies normally have a bypass valve cracking pressure between 25 and 100 PSI (1.7 and 6.9 bar).

The relationship between the starting clean pressure differential across the

filter element and the bypass valve pressure setting must be considered. A cellulose element has a narrow region of exponential pressure rise. For this reason, the relationship between the starting clean pressure differential and the bypass valve pressure setting is very important. This relationship in effect determines the useful life of the filter element.

In contrast, the useful element life of the single layer and multilayer fiberglass elements is established by the nearly horizontal, linear region of relatively low pressure drop increase, not the region of exponential pressure rise. Accordingly, the filter assembly bypass valve cracking pressure, whether 25 or 75 PSI (1.7 or 5.2 bar), has relatively little impact on the useful life of the filter element. Thus, the initial pressure differential and bypass valve setting is less a sizing factor when fiberglass media is being considered.



# Types & Locations of Filters

## Filtration Fact

*Suction strainers are often referred to by "mesh" size:*

*60 mesh = 238 micron*

*100 mesh = 149 micron*

*200 mesh = 74 micron*

## Filtration Fact

*The use of suction filters and strainers has greatly decreased in modern filtration.*

### Filter Types and Locations

- ▼ Suction      ▼ Return
- ▼ Pressure    ▼ Off-line

#### Suction Filters

Suction filters serve to protect the pump from fluid contamination. They are located before the inlet port of the pump. Some may be inlet "strainers", submersed in the fluid. Others may be externally mounted. In either case, they utilize relatively coarse elements, due to cavitation limitations of pumps. For this reason, they are not used as primary protection against contamination. Some pump manufactures do not recommend the

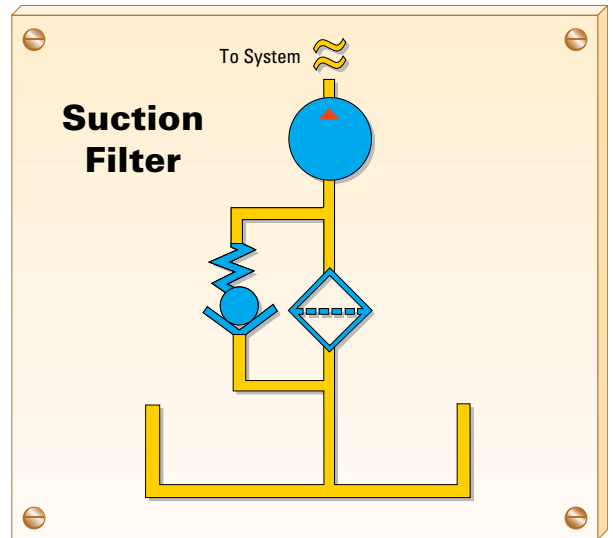

use of a suction filter. Always consult the pump manufacturer for inlet restrictions.

#### Pressure Filters

Pressure filters are located downstream from the system pump. They are designed to handle the system pressure and sized for the specific flow rate in the pressure line where they are located.

Pressure filters are especially suited for protecting sensitive components directly downstream from the filter, such as servo valves. Located just downstream from the system pump,

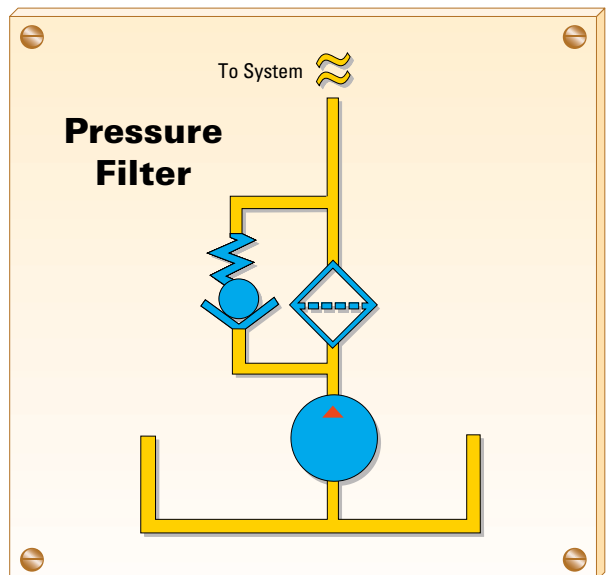

they also help protect the entire system from pump generated contamination.

# Types & Locations of Filters

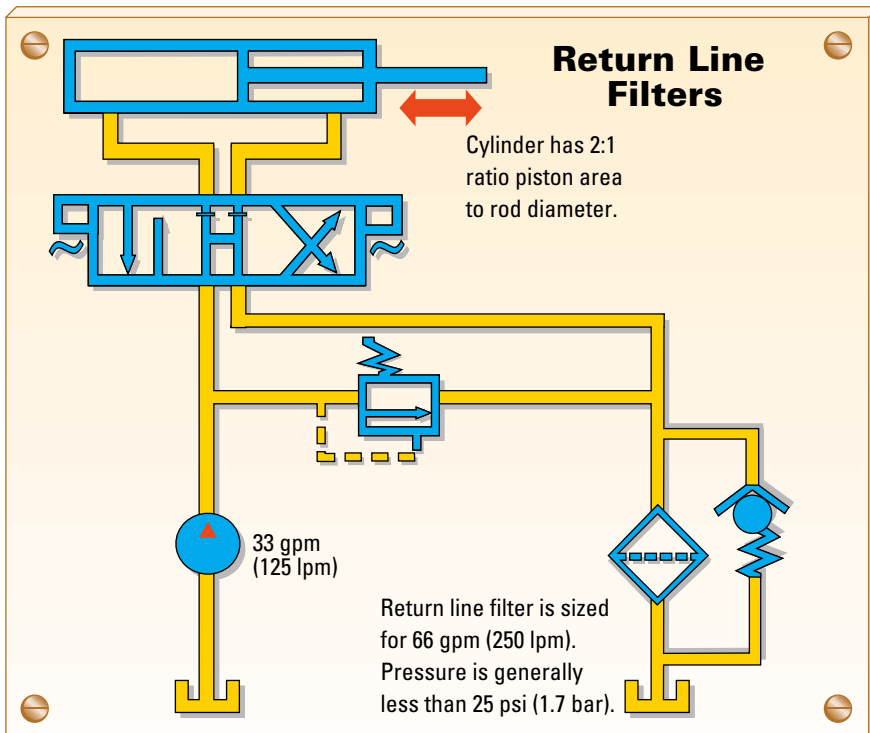

## Return Filters

When the pump is a sensitive component in a system, a return filter may be the best choice. In most systems, the return filter is the last component through which fluid passes before entering the reservoir. Therefore, it captures wear debris from system working components and particles entering through worn cylinder rod seals before such contaminant can enter the reservoir and be circulated. Since this filter is located immediately upstream from the reservoir, its pressure rating and cost can be relatively low.

In some cases, cylinders with large diameter rods may result in “flow multiplication”. The increased return line flow rate may cause the filter

bypass valve to open, allowing unfiltered flow to pass downstream. This may be an undesirable condition and care should be taken in sizing the filter.

Both pressure and return filters can commonly be found in a duplex version. Its most notable characteristic is continuous filtration. That is, it is made with two or more filter chambers and includes the necessary valving to allow for continuous, uninterrupted filtration. When a filter element needs servicing, the duplex valve is shifted, diverting flow to the opposite filter chamber. The dirty element can then be changed, while filtered flow continues to pass through the filter assembly. The duplex valve typically is an open cross-over type, which prevents any flow blockage.

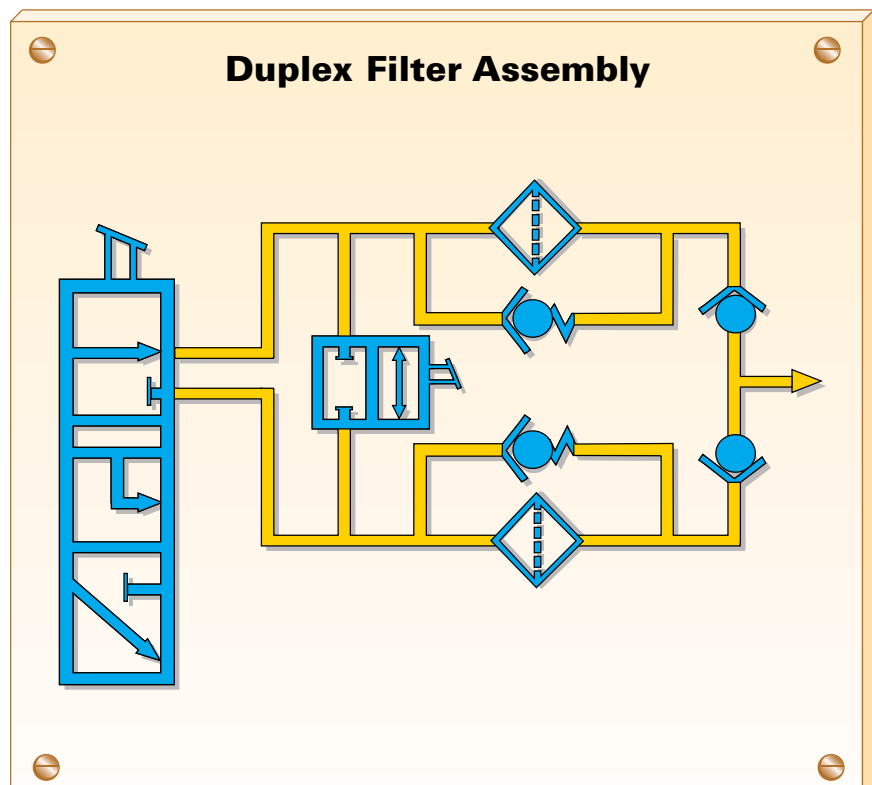



# Types & Locations of Filters

## Filtration Fact

**Rule of thumb:**

**size the pump flow of an off-line package at a minimum of 10% of the main reservoir volume.**

## Filtration Fact

**The cleanliness level of a system is directly proportional to the flow rate over the system filters.**

### Off-Line Filtration

Also referred to as recirculating, kidney loop, or auxiliary filtration, this filtration system is totally independent of a machine's main hydraulic system. Off-line filtration consists of a pump, filter, electrical motor, and the appropriate hardware connections. These components are installed off-line as a small sub-system separate from

the working lines, or included in a fluid cooling loop. Fluid is pumped out of the reservoir, through the filter, and back to the reservoir in a continuous fashion. With this "polishing" effect, off-line filtration is able to maintain a fluid at a constant contamination level. As with a return line filter, this type of system is best suited to maintain overall cleanli-

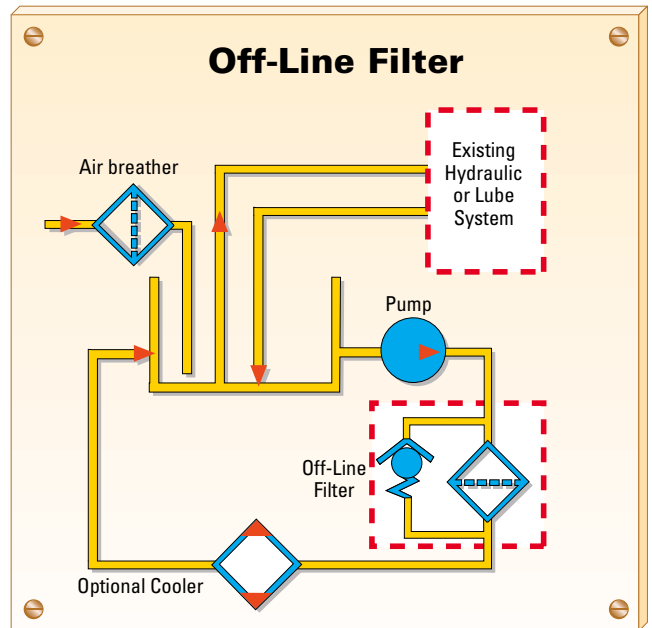

ness, but does not provide specific component protection. An off-line filtration loop has the added advantage that it is relatively easy to retrofit on an existing system that has inadequate filtration. Also, the filter can be serviced without shutting down the main system. Most systems would benefit greatly from having a combination of suction, pressure, return, and off-line filters. The table to the right may be helpful in making a filtration location decision.

### Flow Rate Effect on Off-Line Filtration Performance

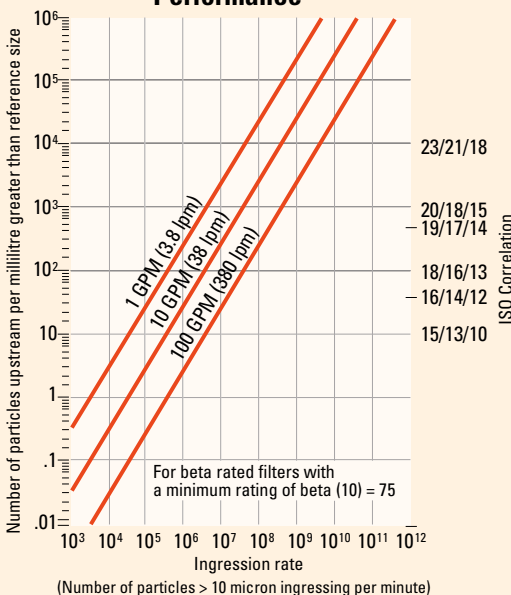

Source based on Fitch, E.C., Fluid Contamination Control, FES, Inc., Stillwater, Oklahoma, 1988.



# Types & Locations of Filters

## Comparison of Filter Types and Locations

FILTER LOCATION	ADVANTAGES	DISADVANTAGES
<b>Suction (Externally Mounted)</b>	<ul style="list-style-type: none"> <li>• Last chance protection for the pump.</li> <li>• Much easier to service than a sump strainer.</li> </ul>	<ul style="list-style-type: none"> <li>• Must use relatively coarse media, and/or large housing size, to keep pressure drop low due to pump inlet conditions.</li> <li>• Cost is relatively high.</li> <li>• Does not protect downstream components from pump wear debris.</li> <li>• May not be suitable for many variable volume pumps.</li> <li>• Minimum system protection.</li> </ul>
<b>Pressure</b>	<ul style="list-style-type: none"> <li>• Specific component protection</li> <li>• Contributes to overall system cleanliness level.</li> <li>• Can use high efficiency, fine filtration, filter elements.</li> <li>• Catches wear debris from pump</li> </ul>	<ul style="list-style-type: none"> <li>• Housing is relatively expensive because it must handle full system pressure.</li> <li>• Does not catch wear debris from downstream working components.</li> </ul>
<b>Return</b>	<ul style="list-style-type: none"> <li>• Catches wear debris from components, and dirt entering through worn cylinder rod seals before it enters the reservoir.</li> <li>• Lower pressure ratings result in lower costs.</li> <li>• May be in-line or in-tank for easier installation.</li> </ul>	<ul style="list-style-type: none"> <li>• No protection from pump generated contamination.</li> <li>• Return line flow surges may reduce filter performance.</li> <li>• No direct component protection.</li> <li>• Relative initial cost is low.</li> </ul>
<b>Off-Line</b>	<ul style="list-style-type: none"> <li>• Continuous "polishing" of the main system hydraulic fluid, even if the system is shut down.</li> <li>• Servicing possible without main system shut down.</li> <li>• Filters not affected by flow surges allowing for optimum element life and performance.</li> <li>• The discharge line can be directed to the main system pump to provide supercharging with clean, conditioned fluid.</li> <li>• Specific cleanliness levels can be more accurately obtained and maintained.</li> <li>• Fluid cooling may be easily incorporated.</li> </ul>	<ul style="list-style-type: none"> <li>• Relative initial cost is high.</li> <li>• Requires additional space.</li> <li>• No direct component protection.</li> </ul>



## Fluid Analysis

### Filtration Fact

***The only way to know the condition of a fluid is through fluid analysis. Visual examination is not an accurate method.***

### Filtration Fact

***Any fluid analysis should always include a particle count and corresponding ISO code.***

- ▼ Patch Test
- ▼ Portable Particle Counter
- ▼ Laboratory Analysis

Fluid analysis is an essential part of any maintenance program. Fluid analysis ensures that the fluid conforms to manufacturer specifications, verifies the composition of the fluid, and determines its overall contamination level.

#### Patch Test

A patch test is nothing more than a visual analysis of a fluid sample. It usually involves taking a fluid sample and passing it through a fine media “patch”. The patch is then analyzed under a microscope for both color and

content, and compared to known ISO standards. By using this comparison, the user can get a “go, no-go” estimate of a system’s cleanliness level.

Another lesser-used deviation of the patch test would be the actual counting of the particles seen under the microscope. These numbers would then be extrapolated into an ISO cleanliness level.

The margin of error for both of these methods is relatively high due to the human factor.

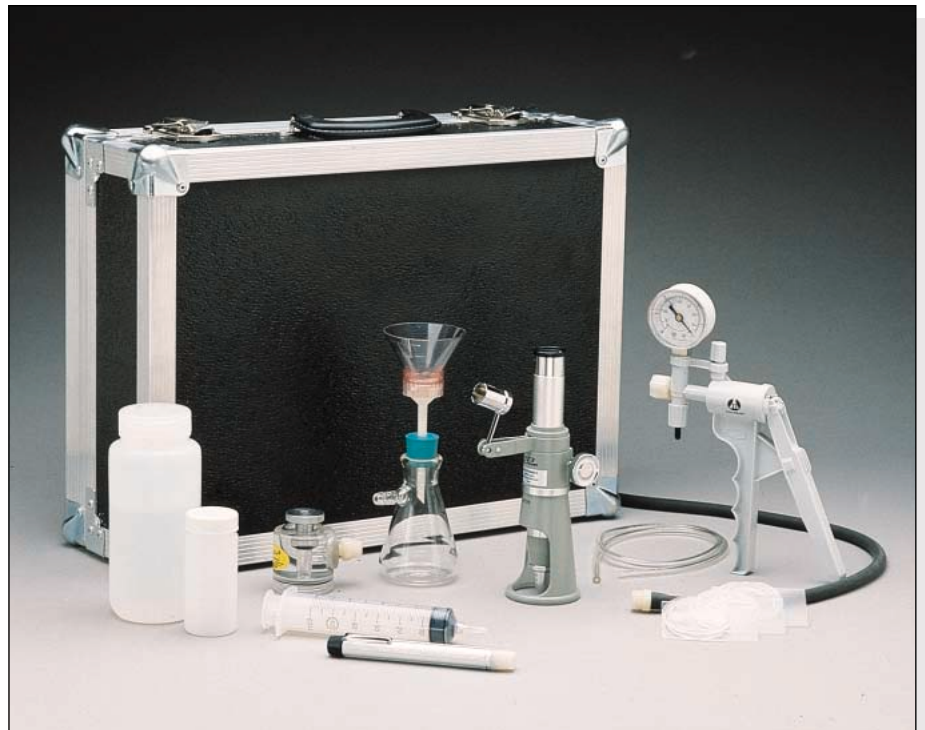

Typical test kit

# Fluid Analysis



Portable particle counter

## Portable Particle Counter

A most promising development in fluid analysis is the portable laser particle counter. Laser particle counters are comparable to full laboratory units in counting particles down to the 2 + micron range. Strengths of this recent technology include accuracy, repeatability, portability, and timeliness. A test typically takes less than a minute. Laser particle counters will generally give only particle counts and cleanliness classifications. Water content, viscosity, and spectrometric analysis tests would require a full laboratory analysis.

## Laboratory Analysis

The laboratory analysis is a complete look at a fluid sample. Most qualified laboratories will offer the following tests and features as a package:

- ▼ Viscosity
- ▼ Neutralization number
- ▼ Water content
- ▼ Particle counts
- ▼ Spectrometric analysis (wear metals and additive analysis reported in parts per million, or ppm)
- ▼ Trending graphs
- ▼ Photo micrograph
- ▼ Recommendations

In taking a fluid sample from a system, care must be taken to make sure that the fluid sample is representative of the system. To accomplish this, the fluid container must be cleaned before taking the sample and the fluid must be correctly extracted from the system.

There is a National Fluid Power Association (NFPA) standard for extracting fluid samples from a reservoir of an operating hydraulic fluid power system. (NFPA T2.9.1-1972). There is also the American National Standard method (ANSI B93.13-1972) for extracting fluid samples from the lines of an operating hydraulic fluid power system for particulate contamination analysis. Either extraction method is recommended.

In any event, a representative fluid sample is the goal. Sampling valves should be opened and flushed for at least fifteen seconds. The clean sample bottle should be kept closed until the fluid and valve is ready for sampling. The system should be at operating temperature for at least 30 minutes before the sample is taken.

A complete procedure follows in the appendix.

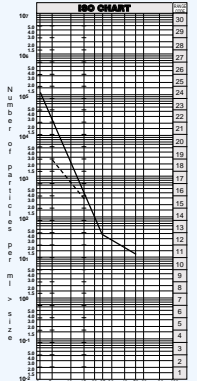
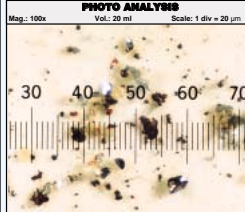
FLUID ANALYSIS REPORT			
SAMPLE CODE: 1004		DATE: 06-01-94	
XYZ Corporation 12345 Middleton Rd. Anywhere USA 41114		 PARTEST Fluid Analysis Service Parker Hannifin Corporation 16810 Fulton County Road #2 McMinn, OH 43109 Tel: (419) 644-4311 Fax: (419) 644-6285	
<b>ALTR:</b>			
<b>SAMPLE DATA</b>			
COMPANY NAME:	XYZ Corporation	SAMPLE DATE:	06-01-94
SYSTEM TYPE:	Hydraulic System	HOURS (est. actual):	100 / 100
EQUIPMENT TYPE:	LOADER	SYSTEM VOLUME:	20 L
MACHINE ID:	x1111	FLUID TYPE:	CTGOL AW 68
FILTER ID:		ANALYSIS PERFORMED:	ALBTVL (V)
<b>AUTOMATIC PARTICLE COUNT SUMMARY</b>		<b>ISO CHART</b>	
Size	Counts per ml.	Cleanliness Code	
> 2 µm	350220		
> 5 µm	344940		
> 10 µm	28420	30/20/14	
> 15 µm	1040		
> 25 µm	170		
> 50 µm	10		
<b>PHOTO ANALYSIS</b> Mag: 100x Vol: 20 µl Scale: 1 div = 20 µm			
			
<b>REMARKS</b> 1. The recommended CLEANLINESS Code is not met. Clean-up maintenance may be warrant. 2. Dotted graph line indicates recommended ISO Code level.			

Laboratory Analysis



## SAMPLING PROCEDURE

Obtaining a fluid sample for particle counts and/or analysis involves important steps to make sure you are getting a representative sample. Often erroneous sampling procedures will disguise the true nature of system cleanliness levels. Use one of the following methods to obtain a representative system sample.

### I. For systems with a sampling valve

**A.** Operate system for a least 1/2 hour.

**B.** With the system operating, open the sample valve allowing 200 ml to 500 ml (7 to 16 ounces) of fluid to flush the sampling port. (The sample valve design should provide turbulent flow through the sampling port.)

**C.** Using a wide mouth, pre-cleaned sampling bottle, remove the bottle cap and place in the stream of flow from the sampling valve. Do **NOT** “rinse” out the bottle with initial sample. Do not fill the bottle more than one inch from the top.

**D.** Close the sample bottle immediately. Next, close the sampling valve. (Make prior provision to “catch” the fluid while removing the bottle from the stream.)

**E.** Tag the sample bottle with pertinent data: include date, machine number, fluid supplier, fluid number code, fluid type, and time elapsed since last sample (if any).

### II. Systems without a sampling valve

There are two locations to obtain a sample in a system without a sampling valve: in-tank and in the line. The procedure for both follows:

#### A. In the Tank Sampling

**1.** Operate the system for at least 1/2 hour.

**2.** Use a small hand-held vacuum pump bottle thief or “basting syringe” to extract sample. Insert sampling device into the tank to one half of the fluid height. You will probably have to weight the end of the sampling tube. Your objective is to obtain a sample in the middle portion of the tank. Avoid the top or bottom of the tank. Do not let the syringe or tubing come in contact with the side of the tank.

**3.** Put extracted fluid into an approved, pre-cleaned sample bottle as described in the sampling valve method above.

**4.** Cap immediately.

**5.** Tag with information as described in sampling valve method.

#### B. In-Line Sampling

**1.** Operate the system for at least 1/2 hour.

**2.** Locate a suitable valve in the system where turbulent flow can be obtained (ball valve is preferred). If no such valve exists, locate a fitting which can be easily opened to provide turbulent flow (tee or elbow).

**3.** Flush the valve or fitting sample point with a filtered solvent. Open valve or fitting and allow adequate flushing. (Take care to allow for this step. Direct sample back to tank or into a large container. It is not necessary to discard this fluid.)



## Sample Multipass Lab Report

4. Place in an approved and pre-cleaned sample bottle under the stream of flow per sampling valve methods above.
5. Cap sample bottle immediately.
6. Tag with important information per the sampling valve method. Note: Select a valve or fitting where the pressure is limited to 200 PSIG (14 bar) or less.

Regardless of the method being used, observe common sense rules. Any equipment which is used in the fluid sampling procedure must be washed and rinsed with a filtered solvent. This includes vacuum pumps, syringes and tubing. Your goal is to count only the particles already in the system fluid. Dirty sampling devices and non-representative samples will lead to erroneous conclusions and cost more in the long run.

<b>Anti-static Additive In Test Fluid</b>	Model	xxxx	<b>Lab Report</b>		xxxx								
	Element	xx	<b>Date</b>		xx								
<b>Element Pressure Drop At Test Termination</b>	Flow	30 Gpm	<b>Tested By</b>		xxx								
	Fab.Int.	10 In Water	<b>Acftd Batch</b>		xxx								
	Fluid	Mil-H-5606/Shell Asa-3 98/102F;14.77-15.3 C	<b>Counts</b>		On-Line								
	Diff. Press.	(PSID)	INJECTION FLUID										
	Terminal	<b>235.0</b>	Grav (MG/L)	Flow (L/Min)									
	Clean Ass'y	5.0	Initial	7 Point									
	Housing	3.2	Final	Average									
	Element	1.8	Average	1253.1      0.453									
	NET	233.2											
	System Gravimetrics (MG/L): Base: 5.0 Final: 11.8												
	<b>% Net</b>	<b>Time</b>	<b>Delta P. Ass'y Elem't</b>	<b>Grams Added</b>	<b>Inject. Flow</b>	Particle Distribution Analysis-Part./H Size (Up/Down/Beta) <b>Particle Size</b>							
						2	3	5	7	10	12		
<b>Test Point Information</b>	<b>Clean Fluid</b>					4.89	2.22	1.11	0.89	0.22	0.00		
<b>% of Net ΔPsi</b>	<b>2.5</b>	25.4	10.8 7.6	14.4	0.451	13,178.00	6,682.00	2,678.00	1,382.00	643.30	436.10		
<b>Duration of Test (Minutes)</b>						10,168.00	2,863.00	340.30	39.55	3.18	0.23		
						1.30	2.33	7.85	34.9	200	1,900		
<b>Assembly ΔPsi</b>	5	<b>31.1</b>	16.7 13.5	17.7	0.455	14,060.00	7,214.00	2,822.00	1,427.00	673.00	463.20		
						11,056.03	3,391.00	406.48	35.91	1.59	0.23		
						1.27	2.13	6.94	39.7	420	2,000		
<b>Element ΔPsi</b>	10	35.8	<b>28.3</b> 25.1	20.3	0.455	13,900.00	7,207.00	<b>2,817.00</b>	<b>Upstream Particle Count</b>				
						10,590.00	3,274.00	395.30					
						1.31	2.20	7.13					
<b>Cumulative Capacity (Grams)</b>	20	39.0	51.6 <b>48.4</b>	22.1	0.453	14,950.00	7,833.00	3,201.00	<b>Downstream Particle Count</b>				
						9,496.00	2,869.00	<b>375.00</b>					
						1.57	2.73	8.54	<b>Test Point Beta Ratio</b>				
<b>Injection Flow (Liters/Min)</b>	40	42.6	98.3 95.1	<b>24.2</b>	0.455	12,410.00	6,696.00	2,857.00	1,495.00	700.70	474.68		
						7,843.00	2,277.83	380.58	38.83	1.82	0.46		
						1.58	2.94	<b>9.51</b>	49.8	390	1,000		
	80	45.1	191.6 188.4	25.6	<b>0.453</b>	11,420.00	6,299.00	2,768.00	1,456.00	681.10	469.30		
						6,152.00	1,709.00	234.30	32.28	5.46	2.50		
						1.86	3.69	11.8	45.1	120	190		
	100	45.9	238.2 235.0	26.1	0.451	11,130.00	6,136.00	2,717.00	1,427.00	669.40	460.90		
						6,013.00	1,690.00	262.50	41.14	8.87	5.23		
						1.85	3.63	10.4	34.7	75.5	88.1		
	Minimum Beta: Ratio's					<b>1.27</b>	2.13	6.94	32.6	75.5	88.1		
	Time Avg. Beta Ratio's					1.36	<b>2.42</b>	7.97	37.2	220	800		
						<b>Final Capacity (Grams): Apparent: 26.1 Retained: 25.8</b>							
						<b>Minimum Beta Ratio For Particle Size During Test</b>		<b>Weighted Avg Beta Ratio For Particle Size Over Test Duration</b>		<b>Cumulative Dirt Added During Test</b>		<b>Calculated Amount Of Grams Retained</b>	



## Viscosity Conversion Chart

cSt (Centistokes)	SUS (Saybolt Universal Seconds)*
10	46
20	93
25	116
30	139
32.4	150
40	185
50	232
70	324
90	417

Comparisons are made at 100° F (38° C). For other viscosity conversion approximations, use the formula:  $cSt = \frac{SUS}{4.635}$

\* NOTE: Saybolt universal seconds may also be abbreviated SSU.

## Metric Conversion Table

TO CONVERT	INTO	MULTIPLY BY
Inches	Millimeters	25.40
Millimeters	Inches	.03937
Gallons	Liters	3.785
Liters	Gallons	.2642
Pounds	Kilograms	.4536
Kilograms	Pounds	2.2046
PSI	Bar	.06804
Bar	PSI	14.5
Centigrade	Fahrenheit	$(^{\circ}C \times \frac{9}{5}) + 32$
Fahrenheit	Centigrade	$(^{\circ}F - 32) / 1.8$
Microns	Inches	.000039
Microns	Meters	.000001

## Viscosity vs. Temperature

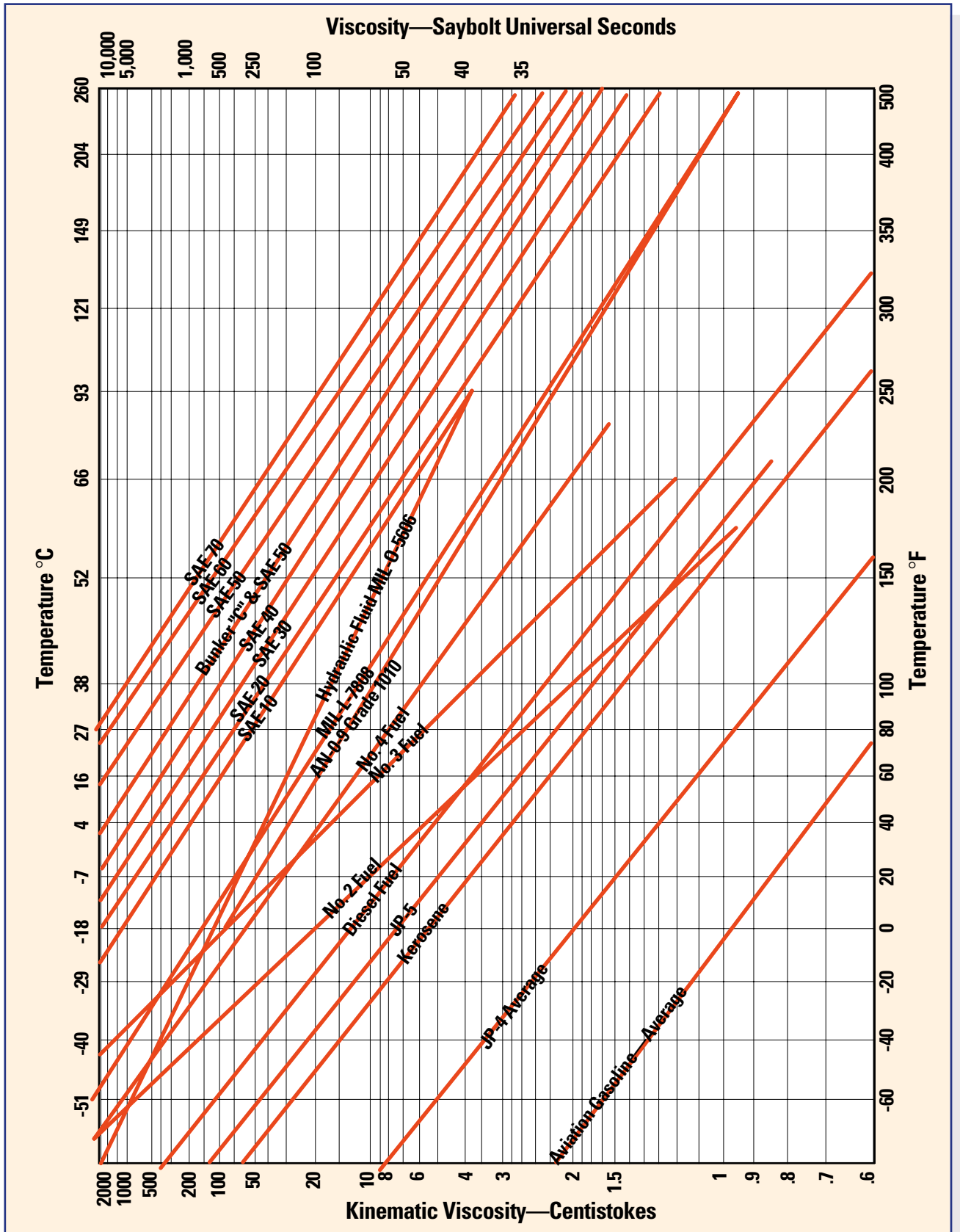

## **Parker Worldwide Sales Offices**

Contact Parker's worldwide service and distribution network by calling:

Argentina • +54 (1) 752 4129  
Australia • +61 (2) 634 7777  
Austria • +43 (2622) 23501 3  
Belgium • +32 (2) 762 1800  
Brazil • +55 (11) 3917 1407  
Canada • 1-800-272-7537  
China • +86 (21) 6249 9755  
Czech Republic • +42 (2) 752544  
Denmark • +45 (43) 541133  
Finland • +358 (0) 8784211  
France • +33 (50) 258025  
Germany • +49 (69) 311096  
Hong Kong • +852 2428 8008  
Hungary • +36 (1) 25 22 539  
India • +91 (22) 577 1671  
Italy • +39 (2) 451921  
Japan • +81 (45) 861-3811  
Korea • +82 (2) 561 0414  
Mexico • 1-800-272-7537  
Netherlands • +31 (5410) 85000  
New Zealand • +64 (9) 573 1523  
Norway • +55 (99) 867760  
Poland • +48 (22) 461455  
Singapore • +65 261 5233  
South Africa • +27 (11) 9703630  
Spain • +34 (1) 6757300  
Sweden • +46 (8) 760 2960  
Taiwan • +886 (2) 781 3206  
United Arab Emirates • +971 (2) 788587  
United Kingdom • +44 1924 487000  
United States of America • 1-800-272-7537  
Venezuela • +58 (2) 238 5422



## **Filtration Group Technical Sales & Service Locations**

### **Finite Filter Division**

500 Glaspie Street  
Oxford, MI 48371  
Phone: (248) 628-6400  
Fax: (248) 628-1850

### **Hydraulic Filter Division**

16810 Fulton County Road #2  
Metamora, OH 43540  
Phone: (419) 644-4311  
Fax: (419) 644-6205

### **Process Filter Division**

1515 W. South Street  
P.O. Box 1300  
Lebanon, IN 46052  
Phone: (765) 482-3900  
Fax: (765) 482-8410

### **Racor Division**

3400 Finch Road  
P.O. Box 3208  
Modesto, CA 95353  
Phone: (800) 344-3286  
Phone: (209) 521-7860  
Fax: (209) 529-3278

### **Racor Division**

Hydrocarbon Products  
Route #3 Box 9  
Henryetta, OK 74437  
Phone: (918) 652-4481  
Fax: (918) 652-8882

### **Filter Division U.K.**

Churwell Vale  
Shaw Cross Business Park  
Dewsbury, England WF12 7RD  
Phone: +44 1924 487000  
Fax: +44 1924 487060

### **Filter Division U.K.**

UCC Products  
P.O. Box 3  
Thetford, Norfolk  
IP24 3RT England  
Phone: (44) 1842-754251  
Fax: +44 1842-753702

### **Finn Filter Division**

Fin-31700  
Urjala As., Finland  
Phone: (358) 3 54 100  
Fax: (358) 3 54 10100

### **Parker Hannifin Ind. e Com. Ltda. Filter Division**

Via Anhanguera, Km. 25,3  
05276-977 – São Paulo  
– SP, Brazil  
Phone: +55 (11) 847 1222  
Fax: +55 (11) 847 1610

### **Parker Hannifin Asia Pacific Company, LTD**

902 Dae Heung Bldg.  
648-23 Yeoksam-dong  
Kangnam-ku, Seoul,  
Korea 135-080  
Phone: 82 2 561 0414  
Fax: 82 2 556 8187

### **Parker Hannifin Corporation Hydraulic Filter Division**

16810 Fulton County Road #2  
Metamora, OH 43540  
Phone: (419) 644-4311  
Fax: (419) 644-6205  
<http://www.parker.com/filtration>